

Preparing your students for success

Mechatronics Resources

21st century learning

Aligned to standards

Knowledge and skills lessons

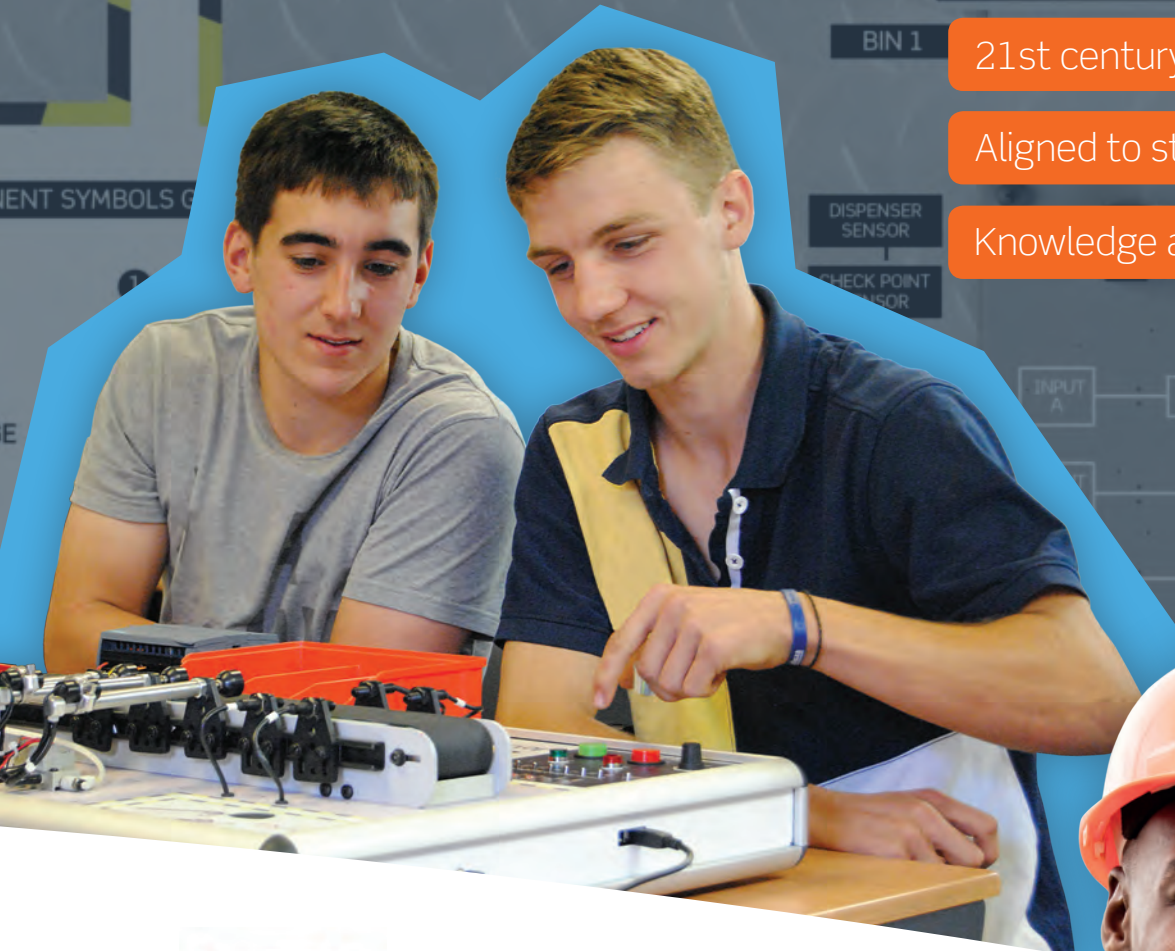

LJ CREATE™
Learning for life

→ Mechatronics Resources



→ Mechatronics

Technical, Academic, and Job Readiness Skills

We are pleased to introduce our cost-effective, mechatronics program. The program is a combination of hundreds of high quality online lessons and reliable training equipment. This flexible Mechatronics program is assembled from the following blocks of instruction:

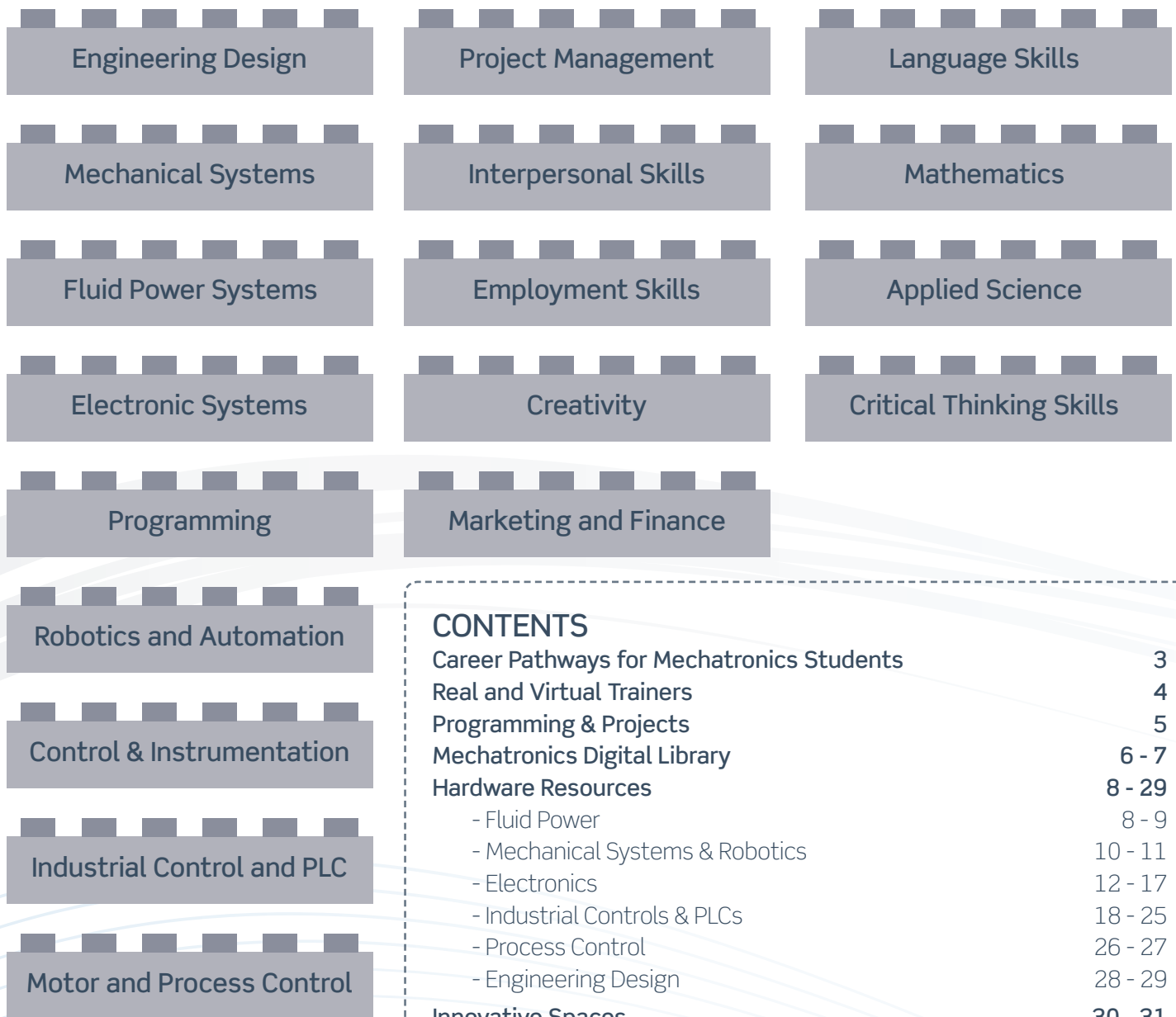

Career Pathways for Mechatronics Students

We can't imagine the range of job skills that will be required by the time this generation of learners are midway through their careers. What they need today is preparation for making informed decisions at the start of a journey of lifelong learning.

Each individual needs to experience a variety of disciplines, be presented with options, and form an opinion of what different skills can lead to. This is our priority in designing curriculum and equipment.



➔ Real and Virtual Trainers

Hardware and Software Working in Tandem

We are able to reduce the cost of a first-class Mechatronics Lab by providing interactive simulators for each of the core training systems.

This means that large groups can learn required skills on-line, while individuals complete the related hands-on challenges.

Our high quality simulators replicate the experience of using the trainers and are provided as a site license - enabling every student to run the system simultaneously. In addition to reducing the initial cost, this methodology also has a dramatic impact on the ongoing budget to run the program.

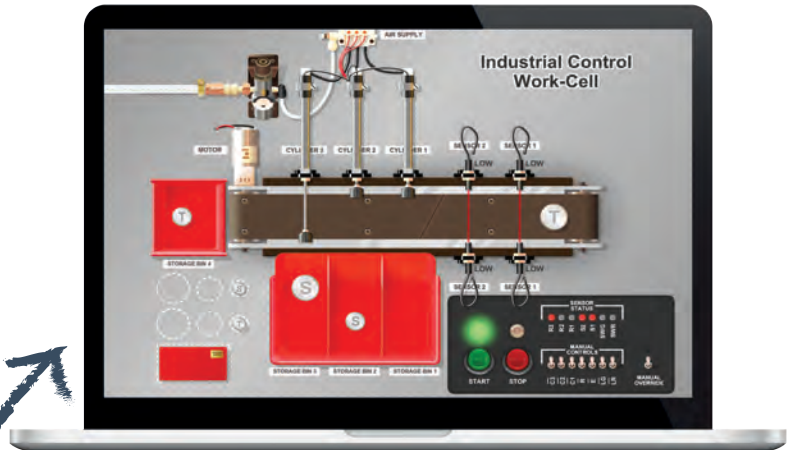
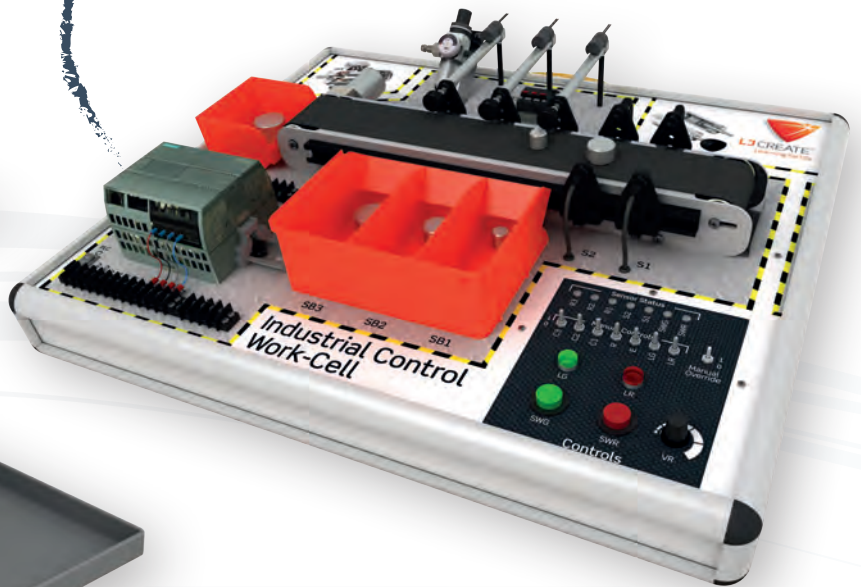
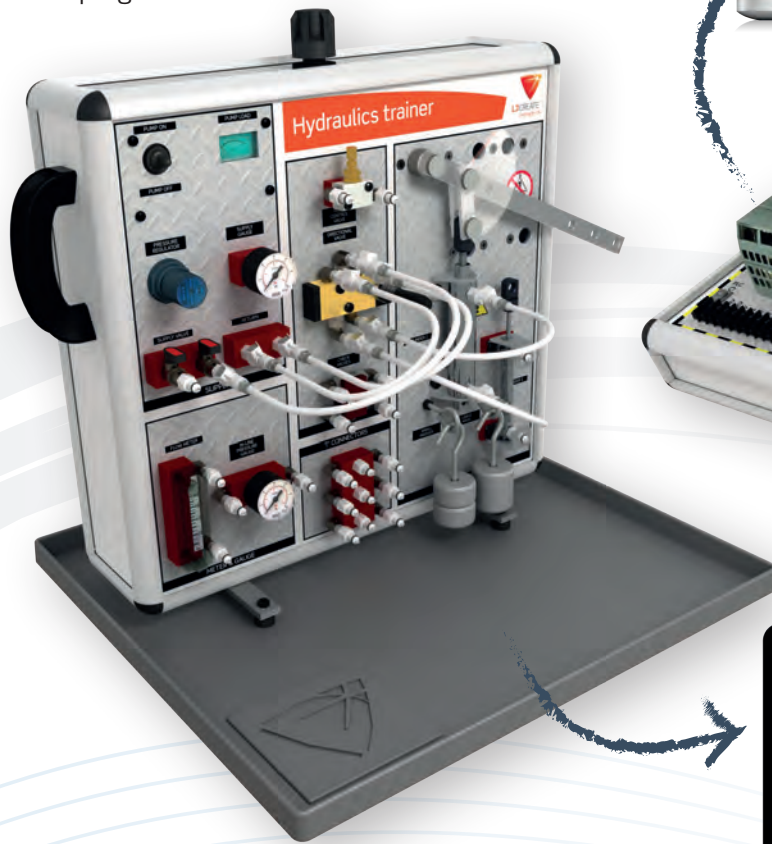

→ Programming & Projects

Open-Ended Challenges for your Students

Completing engineering design projects is at the heart of any good mechatronics program. Projects provide the opportunity for students to use the knowledge and skills they have gained, in a real-world environment.

Our comprehensive program takes all the hard work out of teaching project skills.

We provide open-ended challenges for which we expect a wide range of student solutions. These solutions are then modeled and programmed using a combination of flow-charting and coding.

Project assistance is provided in the form of step-by-step instructions for building and programming sub-systems that students may choose to use in their design - for example, a gearbox. In this way, the online lessons can replace the intensive assistance usually required from a teacher or mentor.

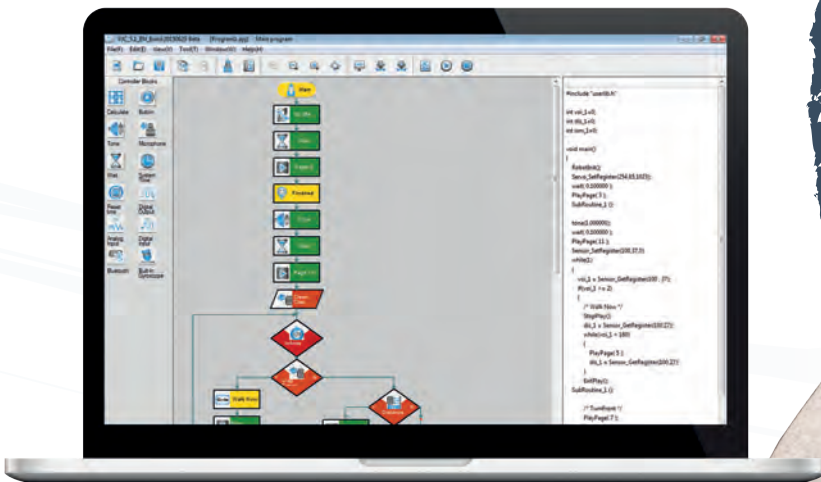

→ Digital Library

Over 1,200 lessons in our extensive Mechatronics library

Our online library is a comprehensive resource of mechatronics lessons. Students can access the presentations, investigations, and assessments

in our library through an online portal; no specialist software or downloads are needed. Below is a small selection of the full topic range:

Engineering Design

- The Design Process
- Engineering Problems
- Alternative Solutions
- Models and Prototypes
- Communicating Engineering Design
- Design Projects
- Building and Testing
- Programming
- Green Technologies
- Construction
- Transportation
- Agriculture

Mechanical Systems

- Machines
- Machine Design
- Friction
- Lubricants, Bushes and Bearings
- Inclined Planes
- Levers
- Gears and Simple Gear Trains
- Pulleys
- Cams and Cranks

Fluid Power Systems

- Principles of Pneumatics
- Pneumatic Cylinders and Valves
- Pneumatic Logic
- Pneumatic Circuit Time Delays
- Levers and Movement
- Principles of Hydraulics
- Hydraulic Applications
- Hydraulic Cylinders
- Hydraulic Valves and Flow Control
- Creating Pressure with Pumps



Electronic Systems

- Electronic Systems
- DC Circuits
- Electrical Networks
- AC Circuits
- Linear Electronics
- Semiconductors
- Power Electronics
- Digital Electronics
- Telecommunications
- Circuit Construction and Testing



Programming

- Algorithms and Problem Solving
- Program Inputs and Outputs
- Program Data, Constants and Variables
- Program Operators and Control Structures
- Program Documentation and Testing
- Program Design Projects
- Computer Systems
- Information Technology
- Microprocessors

Robotics and Automation

- Industrial Robots
- Mobile Robots
- Space Robots
- Manual Control
- Programming
- Pre-Programmed Sequences
- Sensors and Actuators
- Open and Closed Loop Control
- Part Transportation Around a Work-Cell
- Computer Integrated Manufacture
- Design Loop Projects



Control & Instrumentation

- Basic Control Systems Equipment & Terms
- Positional Resistance Transducers
- Wheatstone Bridge Measurements
- Environmental Measurement
- Temperature, Sound and Light Sensing
- Linear Position and Force Applications
- Signal Conditioning
- Comparators, Oscillators and Filters
- Mathematical Operations
- Position and Speed Control Systems

Industrial Control and PLC

- Feedback Control Systems
- Programmable Logic Control
- Construction and Function of a PLC
- Sequence Control System
- PLC Programming
- GRAFCET Sequence Control Systems
- Rotary Encoder
- Conveyor Application Control
- Parts Sorter Application Control
- Step 7 Programming
- Fieldbus, AS Interface, and Profibus DP

Motor and Process Control

- Proportional, Integral and Derivative Control
- Proportional Plus Integral Speed Control
- Proportional Plus Integral Plus Derivative Position Control
- Three-Term, PID Control
- Computer Control

Project Management

- Basics of Storage
- Storage of Goods
- Loading Goods
- Internal Transport and Loading
- Human Resources
- Route Planning
- Stowage Planning
- Event Driven Process Chains
- Information Processing

Interpersonal Skills

- Punctuality
- Dress Code
- Personal Space
- Common Courtesy
- Handling a Telephone Call
- How to Introduce Yourself
- Listening and Understanding
- Engage in a Two-Way Conversation

Employment Skills

- Accessing the Internet
- Using MS Windows
- Word Processing
- Spreadsheets
- Analytical Techniques
- Business Organizational Structure
- Corporate Mission and Goals

Creativity

- Presenting a Persuasive Perspective
- Creating an Informative Text
- Informing an Audience
- Understanding and Using Perspective in a Narrative
- Developing Solutions to Sales and Marketing Scenarios

Marketing and Finance

- Financial Accounting and Bookkeeping
- Balance Sheet Accounting
- Profit and Loss Accounts
- Inventory Accounting Methods
- Marketing Planning
- Product, Advertising, Distribution and the Marketing Mix
- Pricing Strategies

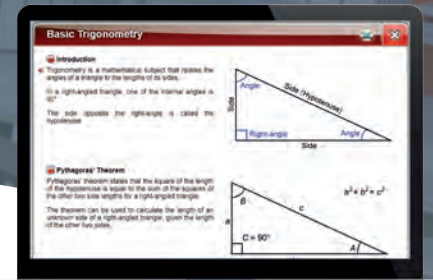

Mathematics

- Units of Measure
- Approximation
- Arithmetic
- Fractions
- Percentages
- Length, Area and Volume
- Indices
- Trigonometry

Language Skills

- Citing Evidence to Support Analysis
- Identifying and Analyzing Ideas in a Text
- Understanding the Role of Structure
- Presenting a Perspective to an Audience
- Speaking on the Telephone
- Arguing a Perspective
- Formal Letters with a Perspective

Applied Science

- Scientific Processes
- Matter
- Forces and Motion
- Energy
- Electricity and Magnetism
- Nuclear Physics
- Chemical Reactions

Critical Thinking Skills

- Developing Solutions to Production Scenarios
- Developing Solutions to Construction Scenarios
- Developing Solutions to Finance Scenarios
- Developing Solutions to Customer Service Scenarios



Fluid Power Hardware

Hydraulics Trainer (280-01)

The Hydraulics Trainer offers a portable classroom-based resource for practical investigation of hydraulic components and systems. The trainer uses quick-release hydraulic hoses to allow rapid circuit connection and setup. A Fluid Power Student Resource Pack is ideal for a whole-class introduction to fluid control using syringes and hoses.

Order as:

- 280-01 Hydraulics Trainer

Also available:

- 278-01 Fluid Power Student Resource Pack



(includes unique Hydraulics simulation software)

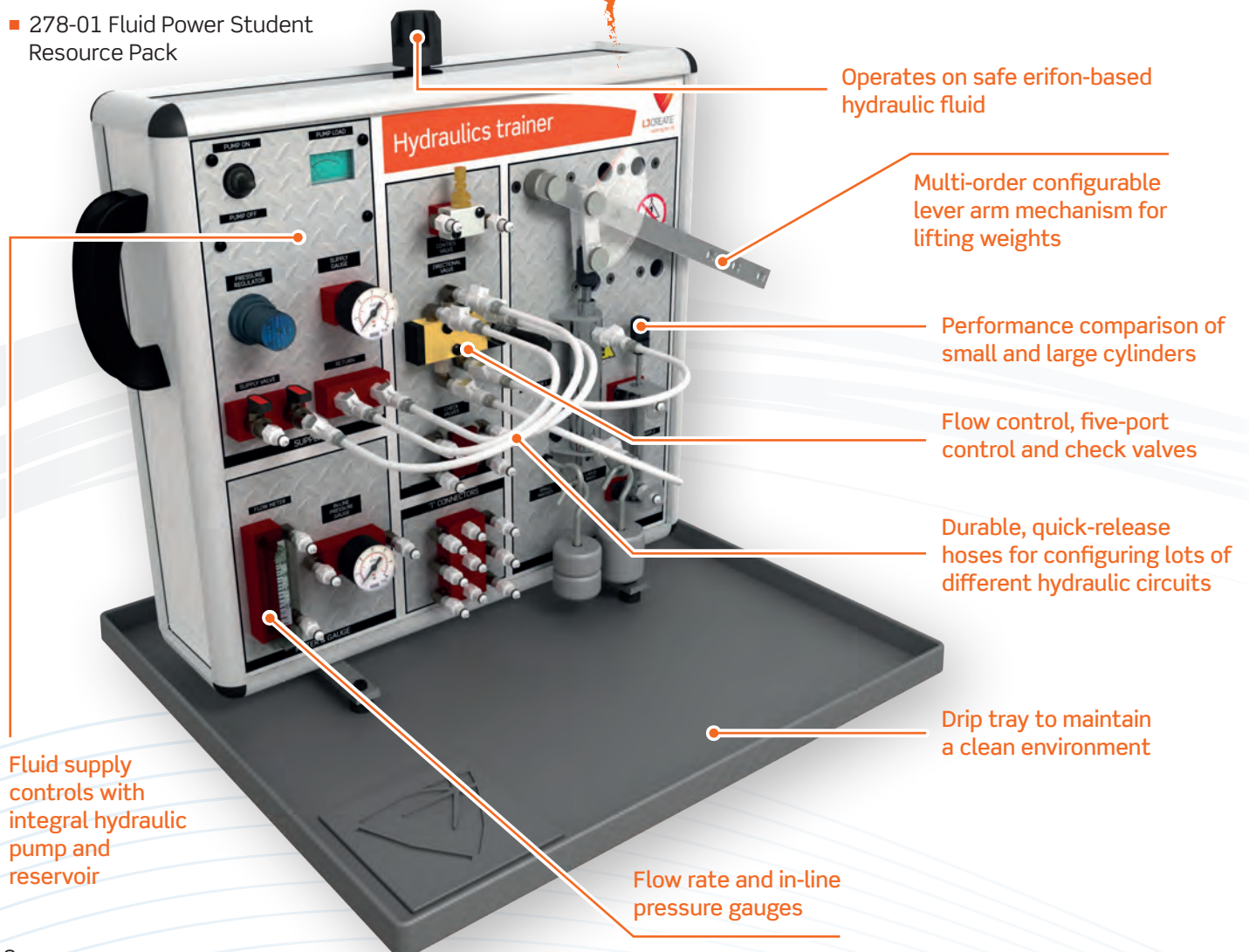

Pneumatics Trainer (270-01)

This classroom-based resource is used for practical investigation of pneumatic components and systems. The trainer allows users to connect components to create fundamental circuits.

Order as:

- 270-01 Pneumatics Trainer

Air supply connection with filter regulator to run off supplied hand pump or external air supply

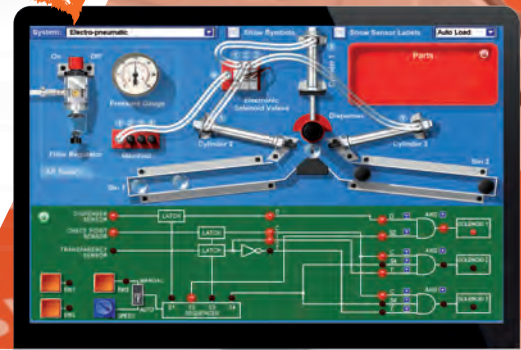
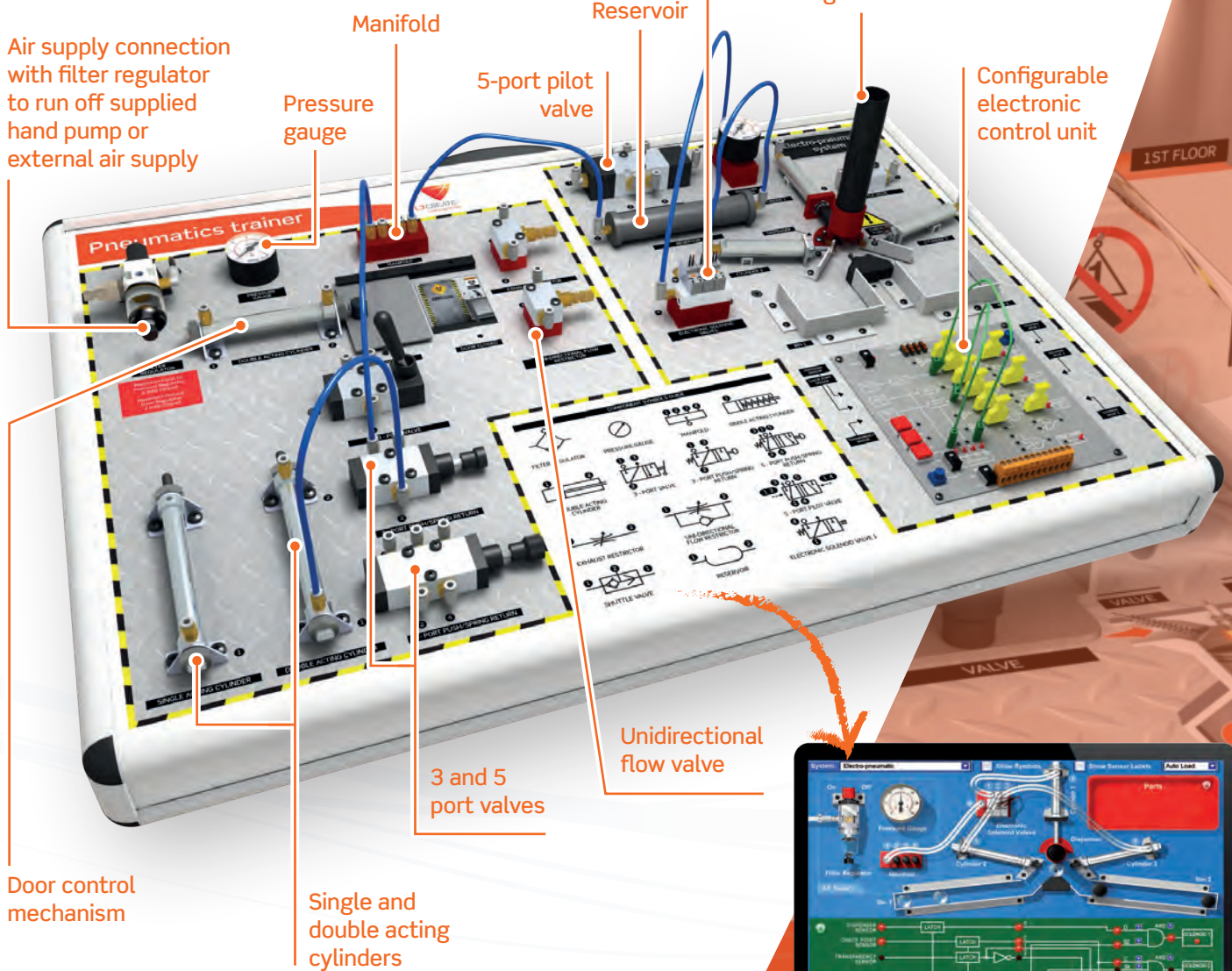

(includes unique Pneumatics simulation software)

Mechanical Systems & Robotics Hardware

Mechanisms Trainer (260-01)

The Mechanisms Trainer offers a classroom-based resource for practical investigation of a variety of fundamental mechanical systems. The trainer allows users to investigate gears, pulleys, levers, cams, belt drives, and inclined planes.

Order as:

- 260-01 Mechanisms Trainer



(includes unique Mechanisms simulation software)

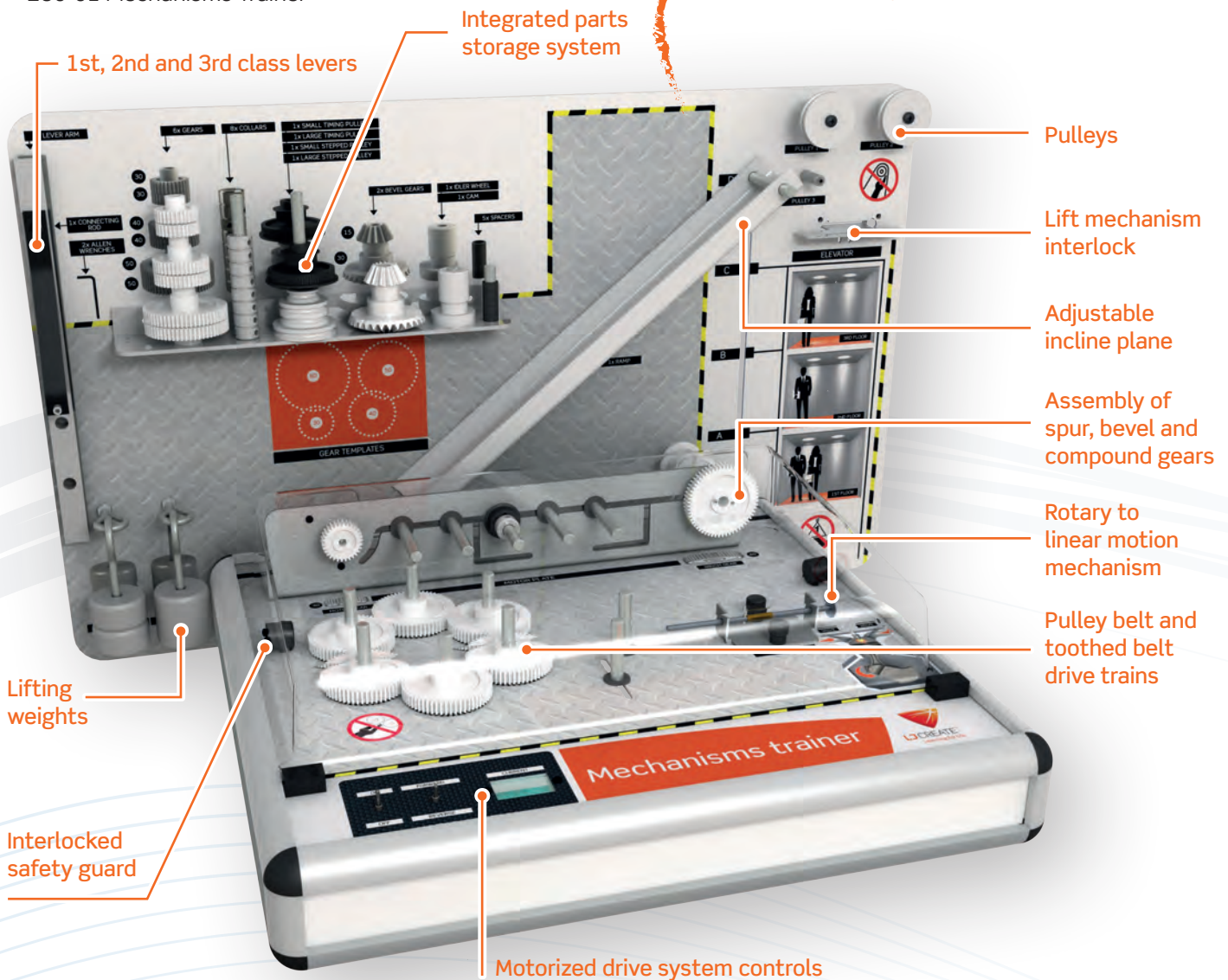

Electronics Hardware

Electronics Study Trainer (320-00)

The Electronics Study Trainer provides the basis for a practical resource that introduces students to core electronics and electronic systems through a wide range of practical activities.

The study trainer allows a range of experiment cards to be connected for the practical study of electronics.

Order as:

- 320-00 Electronics Study Trainer

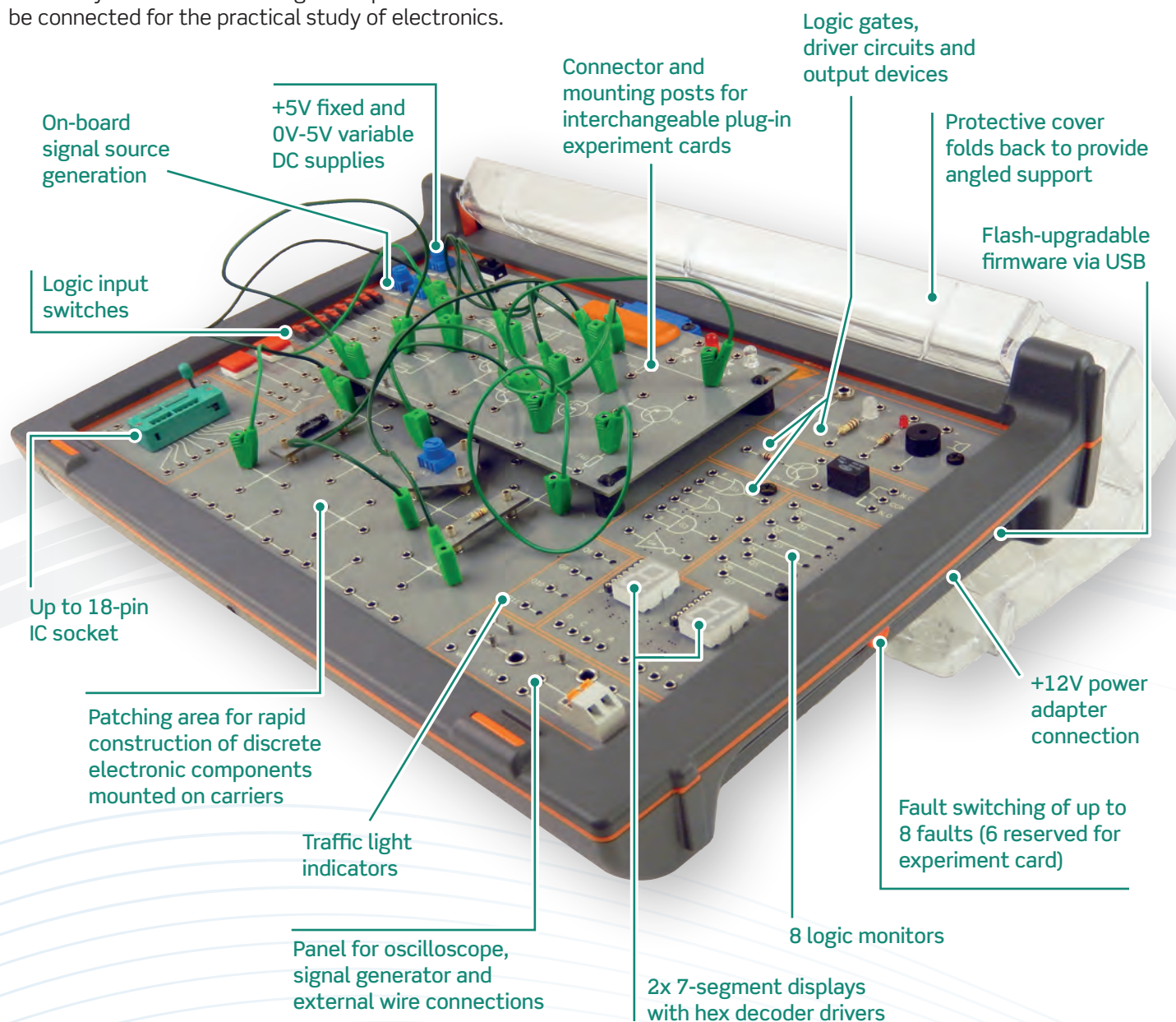

Complete Electronics Workstation (320-10)

The core electronics series allows the practical study of a wide range of electronics subjects, including DC and AC circuits, semiconductors, analog and digital systems, telecommunications, and microcontrollers.

The series comprises an electronics study trainer and component set, and a range of plug-in experiment cards. The unique design of the trainer includes a heavy duty casing with transparent protective cover.

When in use, the cover folds back to provide an angled support for the unit. With the cover closed, trainers become stackable for easy storage.

Order as:

- 320-10 Complete Electronics Workstation (includes 320-00 to 320-61)

Compartmentalized storage system

Interchangeable experiment cards

Discrete electronic components mounted on carriers

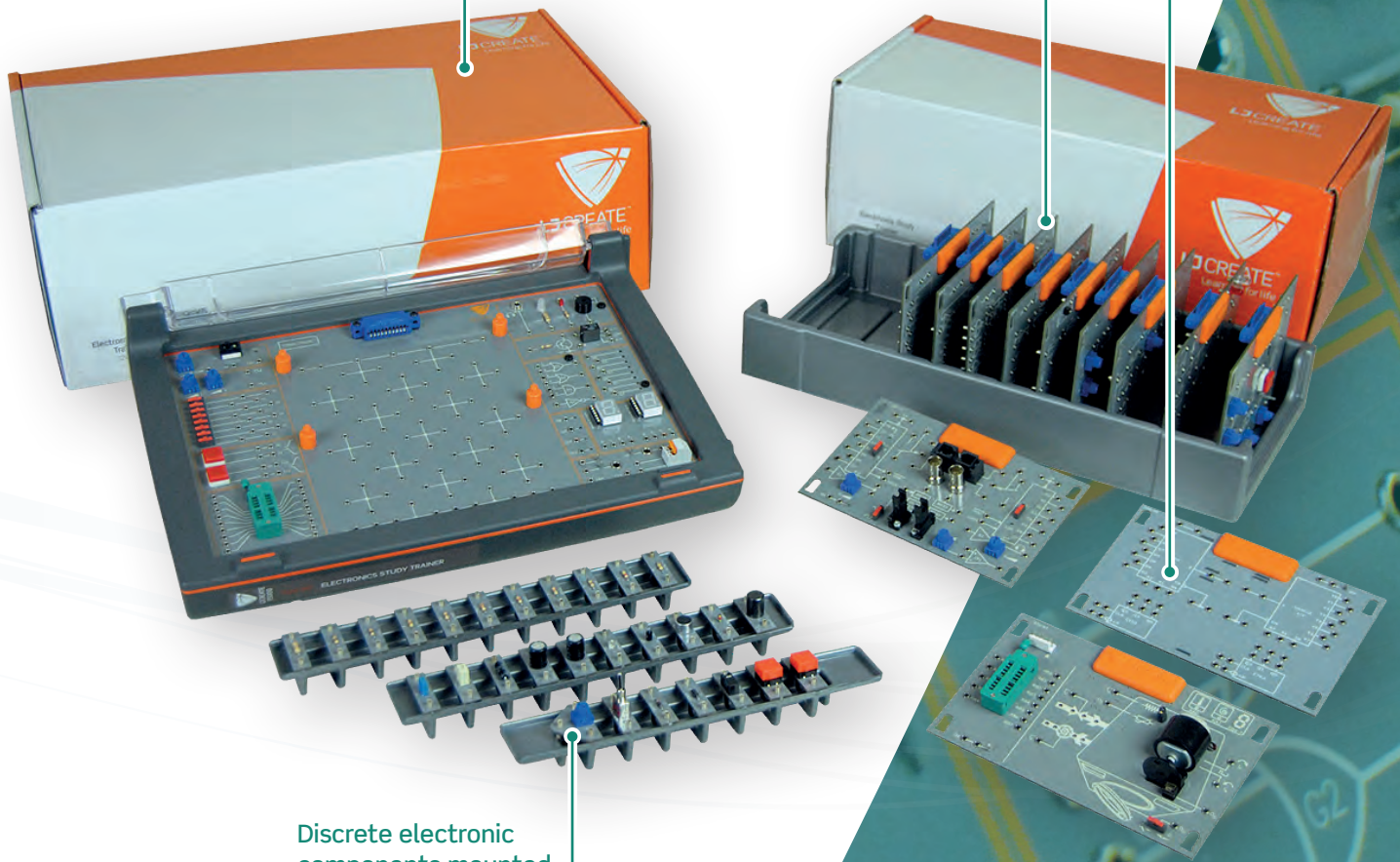

Electronics Hardware

Our completely re-designed core electronics series is a perfect blend of component-based and systems training.

- Patch discrete components quickly and easily
- Add an interchangeable study card for more complex circuits
- Or combine the two for even more flexibility!
- Controlled troubleshooting faults that really test circuit understanding

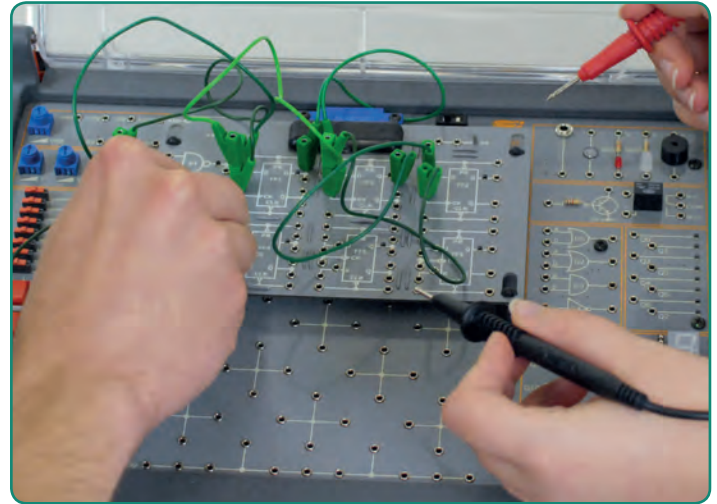

Please note: these circuit cards are used in conjunction with 320-00 Electronics Study Trainer

Electronic Systems Card (320-01)

The Electronic Systems Card introduces students to the principles of electronic systems through the interconnection of a variety of input, process and output subsystems.

Typical practical tasks and topics include:

- Darlington pair and FET investigation
- Thyristor investigation
- Automatic lighting project
- Baby alarm project
- Intruder alarm system project
- Testing and fault-finding

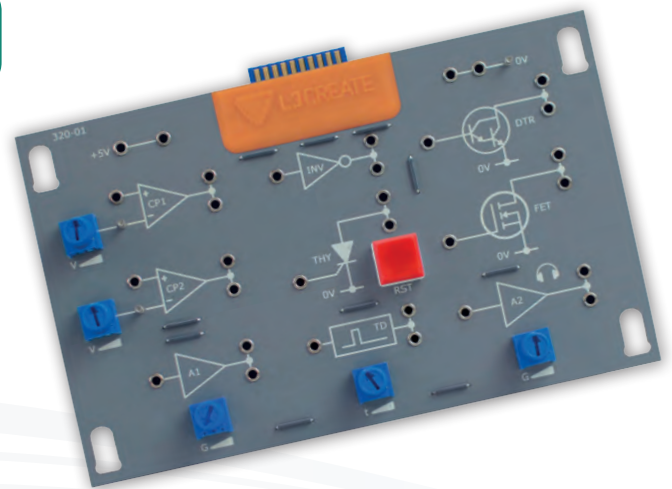

Electromagnetism Card (320-14)

The Electromagnetism Card introduces students to the principles and applications of electromagnetism.

Typical practical tasks and topics include:

- Reed switch operation
- Hall effect investigation
- Field strength of an electromagnet
- Field shape and direction for an electromagnet
- Electromagnetic induction and solenoid operation
- Transformer power and efficiency
- DC motor-generator investigation
- Fault-finding electromagnetic devices

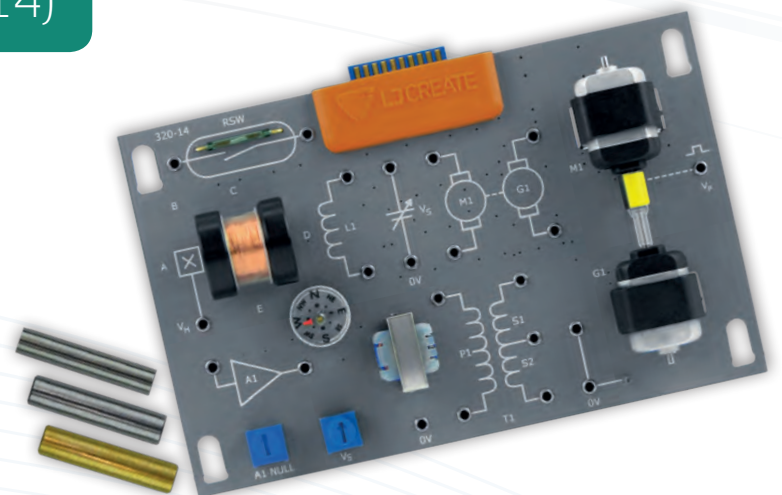

Diodes and Transistors Card (320-21)

The Diodes and Transistors Card allows students to investigate semiconductor diodes and transistors through a range of practical activities.

Typical practical tasks and topics include:

- Voltage stabilization using a zener diode
- NPN transistor as a voltage amplifier
- FET operation
- Testing and fault-finding diode and transistor circuits

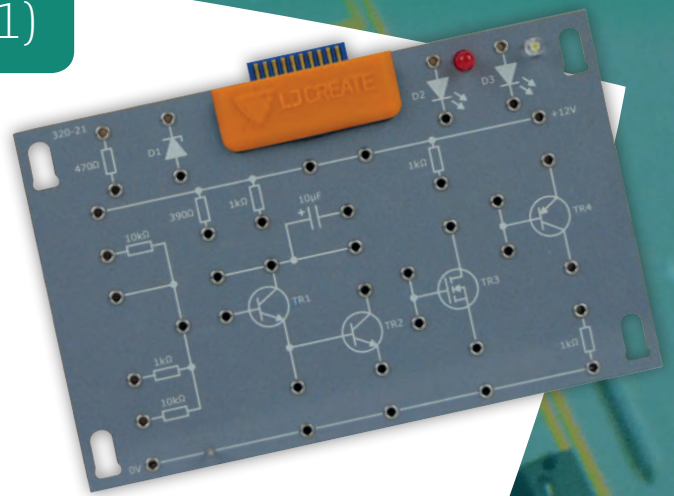

Transistor Amplifiers Card (320-22)

The Transistor Amplifiers Card allows students to investigate transistor amplifier circuits through a range of practical activities.

Typical practical tasks and topics include:

- Build and test Class A, B, AB and C transistor amplifiers
- Investigate crossover distortion
- Effects of feedback in a transistor amplifier circuit
- Fault-finding transistor amplifier circuits

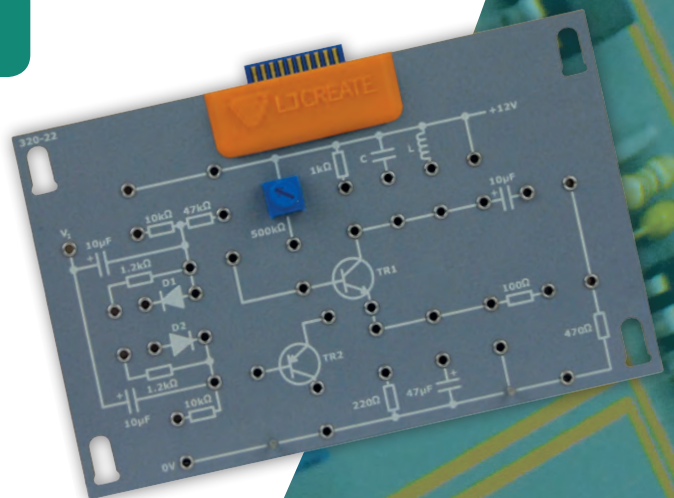

Operational Amplifiers Card (320-31)

The Operational Amplifiers Card allows students to investigate operational amplifier circuits through a range of practical activities.

Typical practical tasks and topics include:

- Investigating a voltage comparator circuits
- Building and testing inverting & non-inverting amplifiers
- High frequency performance of an operational amplifier
- Fault-finding operational amplifier circuits

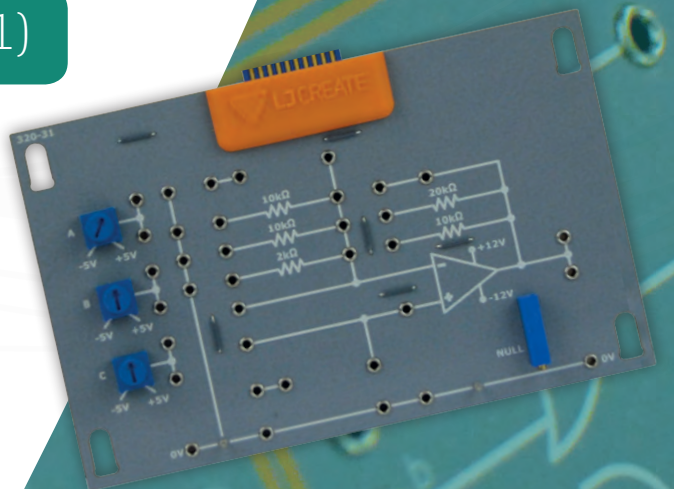

Analog Integrated Circuits Card (320-32)

This card allows students to investigate a variety of analog integrated circuits through a range of practical activities.

Typical practical tasks and topics include:

- Comparing linear and switch mode voltage regulators
- Testing a switched capacitor filter
- Investigating the operation of a phase locked loop
- Fault-finding analog integrated circuits

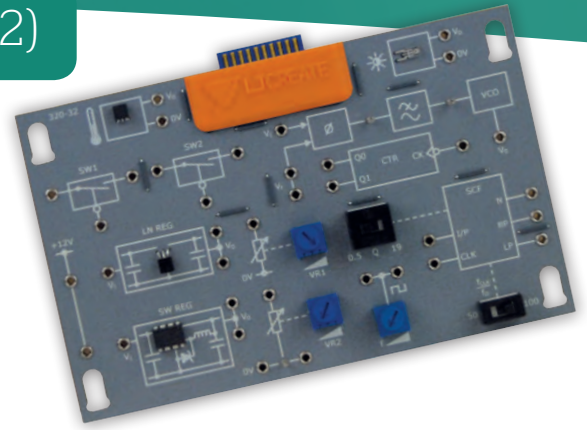

Combinational Logic Card (320-41)

The Combinational Logic Card introduces students to combinational logic through a range of practical activities.

Typical practical tasks and topics include:

- Investigating logic gates
- Constructing truth tables
- Building EXOR gates from other gates
- Testing and fault-finding combinational logic systems

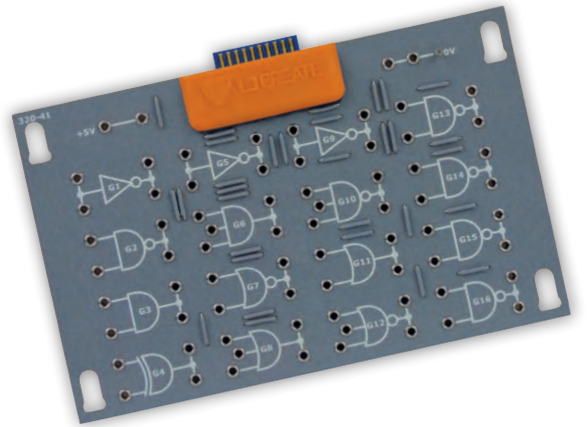

Sequential Logic Card (320-42)

The Sequential Logic Card introduces students to sequential logic through a range of practical activities.

Typical practical tasks and topics include:

- D-type and J-K flip-flop
- Binary counter operation
- Frequency division
- Testing and fault-finding sequential logic systems

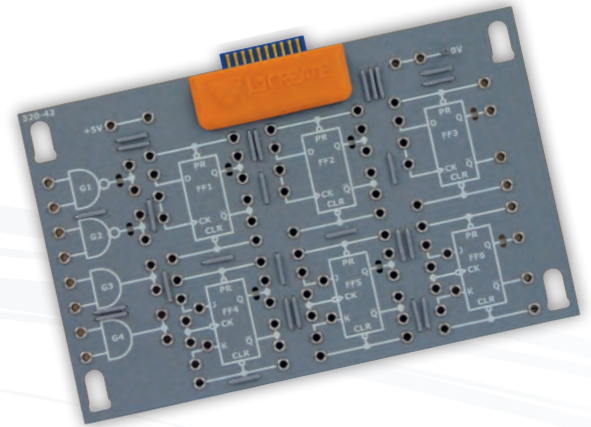

A/D-D/A Digital Systems Card (320-43)

This card introduces students to digital-to-analog conversion, analog-to-digital conversion, and bus control through a range of activities.

Typical practical tasks and topics include:

- Investigating a D/A converter
- Building and testing an A/D converter
- Testing and fault-finding A/D and D/A systems

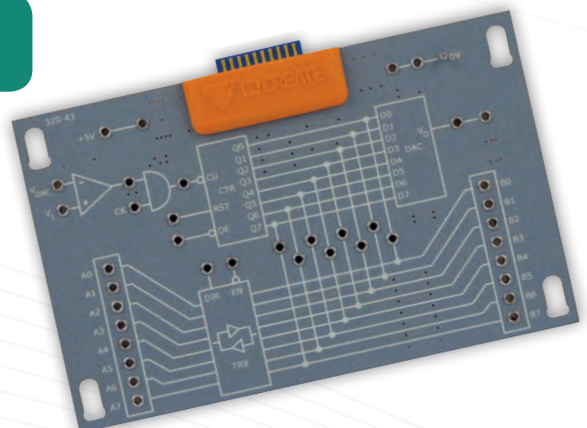

Encoder/Decoder Digital Systems Card (320-44)

The Encoder/Decoder Digital Systems Card introduces students to digital encoders and decoders through a range of practical activities.

Typical practical tasks and topics include:

- Investigate digital encoders
- Decoding the output from a binary counter
- Building and testing an encoder-decoder system
- Fault-finding an encoder-decoder system

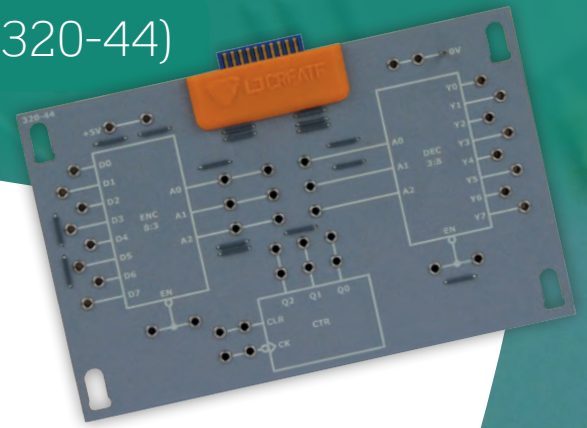

Multiplexer/Demultiplexer Digital Systems Card (320-45)

This card introduces students to digital multiplexers and demultiplexers through a range of practical activities.

Typical practical tasks and topics include:

- Scanning multiplexer inputs using a binary counter
- Building and testing multiplexers/demultiplexers
- Clocking and synchronization
- Fault-finding multiplexer/demultiplexer systems

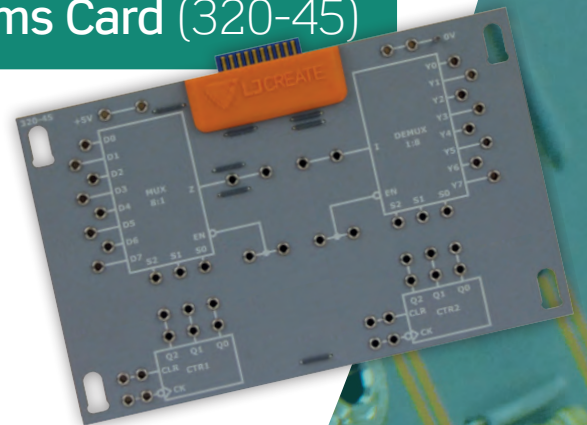

Electronic Communications Card (320-51)

This card introduces students to the principles of electronic communication systems through a range of practical activities.

Typical practical tasks and topics include:

- AM and optical transmission
- Digital data transmission
- Simplex and duplex transmission
- Fault-finding electronic systems

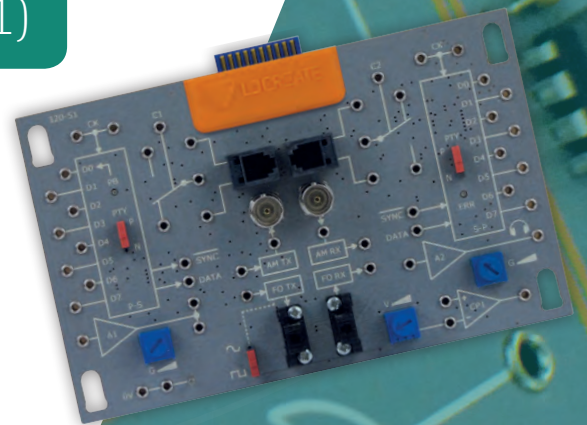

PIC Programmer and Applications Card (320-61)

This card introduces students to programming microcontrollers through a range of activities based around a simulation of a washing machine.

Typical practical tasks and topics include:

- Investigating sensors and actuators
- Controlling I/O port lines
- Using sub-routines

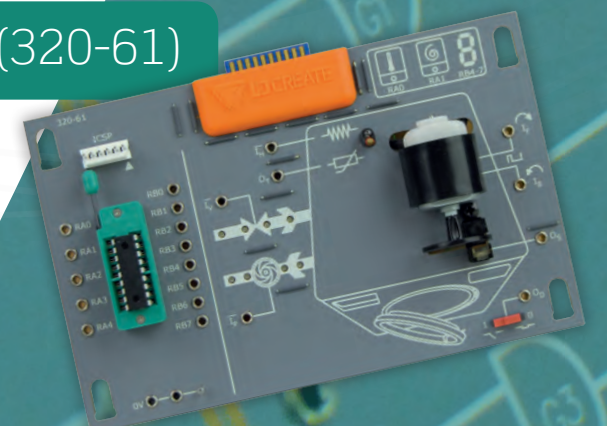

Industrial Controls & PLCs Hardware

Typical Program Sequence

This sequence of instruction is designed to take every learner on a journey from beginner to industrial controls expert.

It is supported by high quality lessons, simulators and hardware at each step.

To complete the entire program takes about 90 contact hours - with expansion activities available for those students and apprentices who want to go further.

*Please Note: For Commercial PLC Programming, lessons are provided for Siemens S71200 - STEP 7 and Allen Bradley Micrologix820



Pneumatic Control
- 270-01
(see the hardware on p9)

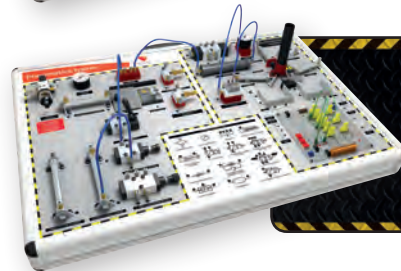

Pneumatic Logic Circuits - 270-01
(see the hardware on p9)

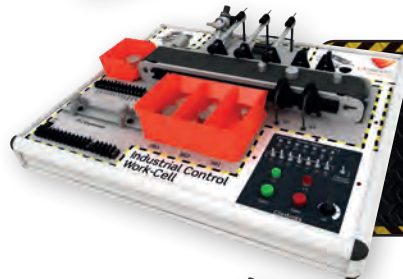

Ladder Logic Programming - 290-01
(see the hardware on p19)

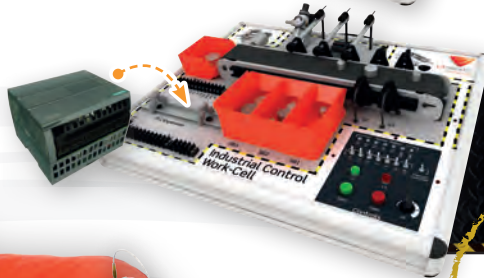

Commercial PLC Programming* - 290-00/AB (or /SI)
(see the hardware on p20)

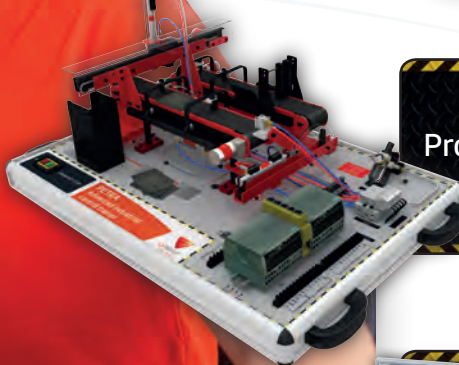

Control of Multiple Programmable Controllers - 292-00/AB (or /SI)
(see the hardware on p22-23)



SCADA - 292-04
(see p22-23)



Industrial Control Trainer (290-01)

This is our best-selling product - and with good reason. The easy-to-use ladder programming software and simulator makes this the easiest trainer available for taking students through the hardest part of their industrial controls learning.

Students follow instructions and complete challenges starting with simple tasks but quickly ramping up to commercial level programming skills.

The trainer is available stand-alone (including a site license for the software) or packaged with one of two industry-standard commercial controllers.

Order as:

- 290-01 Industrial Control Trainer

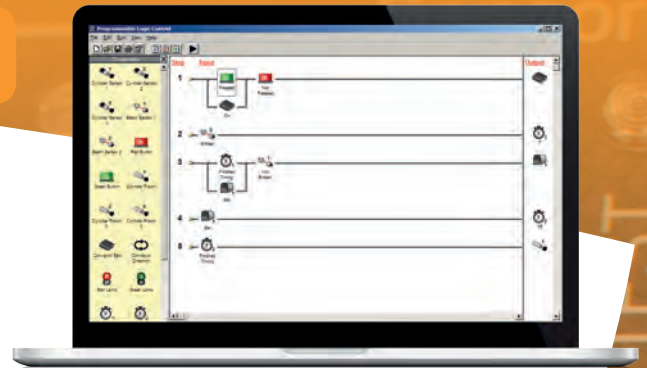

(includes ladder logic programming software)

Conveyor belt part sorting system

Reject parts bin

3x Electro-pneumatic controlled cylinders

2x Infrared beam sensors for measuring part size

Industrial Control Work-Cell

Sorted parts bin

Manual control panel with sensor status indication

USB interface for direct control by programs written in our bespoke ladder logic programming editor on a PC



(includes unique PLC simulation software)

Industrial Controls & PLCs Hardware

Industrial Control Teaching Set - Siemens (290-00/SI)

Packaged with a Siemens S71200 Controller and a single license for Step 7 programming software - the lessons accompanying this teaching set take students from basic PLC operation, through ladder programming to the application of commercial software.

Order as:

- 290-00/SI Industrial Control Teaching Set - Siemens

Teaching set includes:

- 290-01 Industrial Control Trainer
- 290-02/SI Siemens S71200 + Step 7 PLC pack

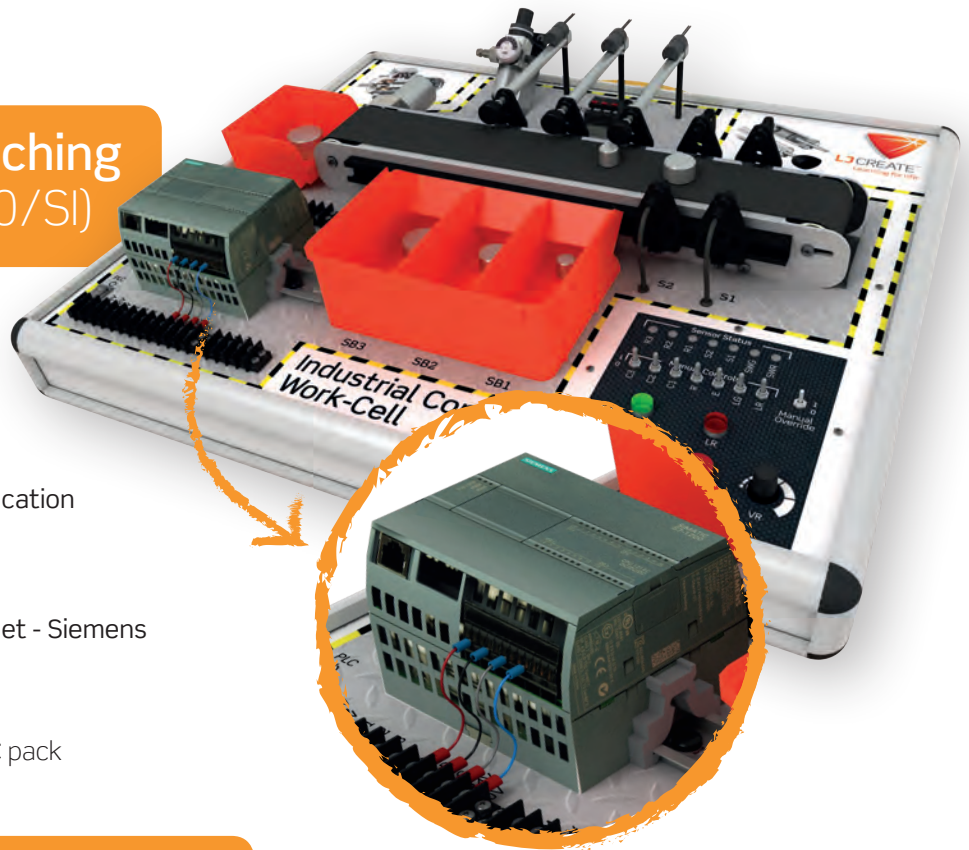

Industrial Control Teaching Set - Allen Bradley (290-00/AB)

Packaged with an Allen Bradley Micrologix820 Controller and a single license for the AB programming software - the lessons accompanying this teaching set take students from basic PLC operation, through ladder programming to the application of commercial software.

Order as:

- 290-00/AB Industrial Control Teaching Set - Allen Bradley

Teaching set includes:

- 290-01 Industrial Control Trainer
- 290-02/AB Allen Bradley Micrologix820 + Software Pack

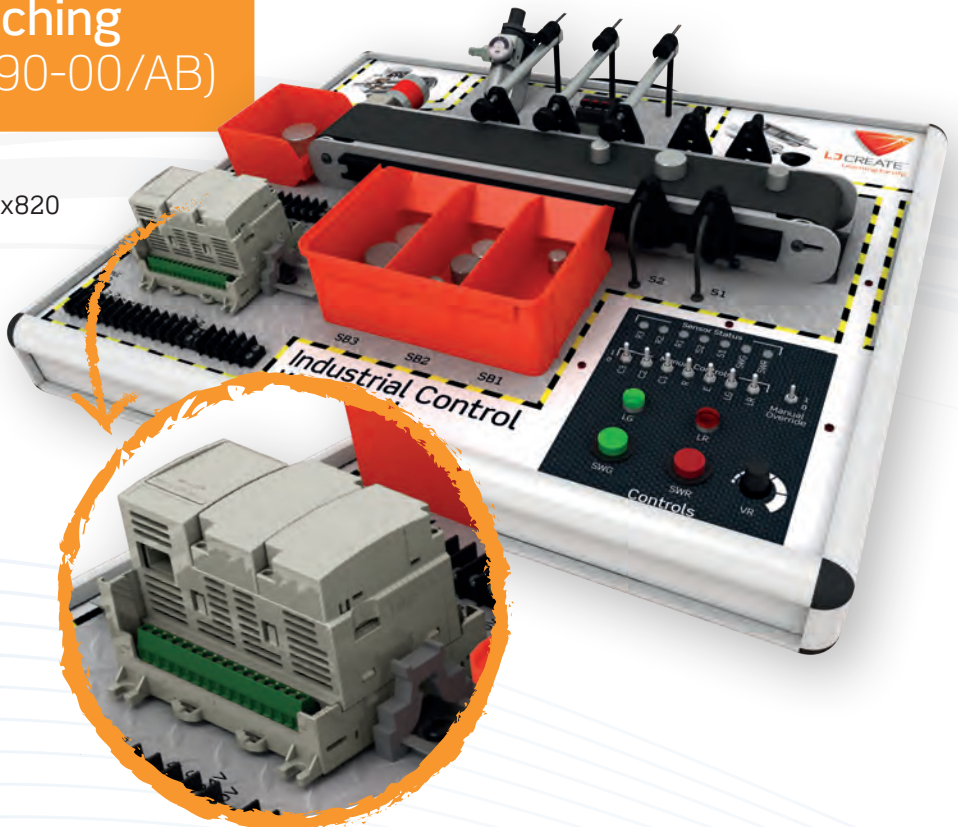

PLCs Trainer Teaching Set - Siemens (291-00/SI)

This is our lowest cost option for a general PLC application. This desktop-based unit is available by itself for use with any industrial controller, or we can package the unit with a Siemens or Allen Bradley controller with corresponding lessons to match.

The trainer includes a rotary encoder for the PLC to monitor and control the speed and position of a motor.

Order as:

- 291-00/SI PLCs Trainer Teaching Set - Siemens

Teaching set includes:

- 291-01 PLCs Trainer
- 290-02/SI Siemens S71200 + Step 7 PLC Pack

Also available:

- 291-00/AB PLCs Trainer Teaching Set - Allen Bradley

Typical practical tasks and topics include:

- Create ladder logic programs
- Logic, truth tables, and step logic
- Counting parts and timing events
- Speed and position motor control
- Rotary encoder monitoring

Parts dispenser

Analog motor-controlled
sorting disc with infrared
hole detection sensor

Sorted parts bins

Siemens PLC - programs
are developed in the Step 7
programming software on
the PC and downloaded to
the Siemens PLC to control
the sorting disc

Manual control panel with
sensor status indication

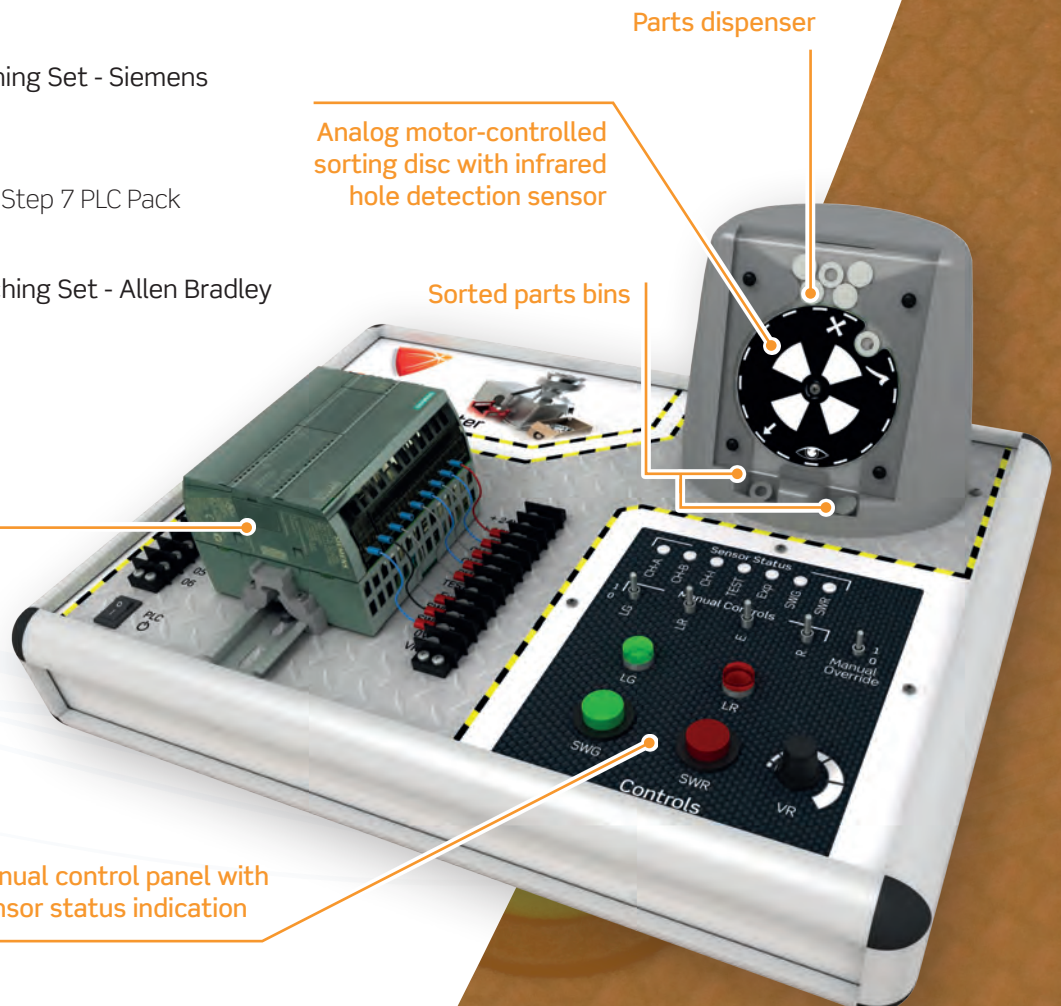

Industrial Controls & PLCs Hardware

PETRA Advanced Industrial Control Trainer (292-01)

Once students have learned to program and troubleshoot a single controller and plant, the next step is to link multiple units together and monitor the performance and operation of a more complex system. This is the role of our PETRA.

The trainer achieves this with a simulated industrial plant containing two distinct processes each controlled by its own PLC. An HMI (human-machine-interface) touch panel unit supervises the two PLCs, monitoring and displaying key information from sensors around the plant.

Using an industry-standard PLC programming software suite, each PLC must be programmed to control its own set of processes. The HMI panel must be programmed to supervise the two PLCs and display relevant plant information.

A student progressing through this program will explore the functionality of SCADA (Supervisory Control and Data Acquisition).

O/P Pneumatic cylinder for pick-and-place plunger suction

I/P Opto-reflective sensor for slot detection

O/P Conveyor 1 motor

Order as:

- 292-01 PETRA Advanced Industrial Control Trainer

Also Available:

- 292-00/SI PETRA Advanced Industrial Control Teaching Set - Siemens (Includes 292-01 and 290-02/SI)
- 292-00/AB PETRA Advanced Industrial Control Teaching Set - Allen Bradley (Includes 292-01 and 290-02/AB)
- 290-02/SI Siemens S71200 + Step 7 PLC Pack
- 290-02/AB Allen Bradley Micrologix820 + Software Pack
- 292-03/SI Siemens HMI Pack for PETRA Advanced Industrial Control Trainer (Includes 2x PLCs, STEP 7 Software, HMI Panel)
- 292-04 SCADA Pack for PETRA Advanced Industrial Control Trainer (Requires 292-01 and 292-03/SI)

O/P Pneumatic cylinder for pick-and-place transport

I/P Positional micro-switches (x4)

I/P Pneumatic sensor to detect correct part thickness

I/P Parts dispenser with 'dispenser empty' sensor

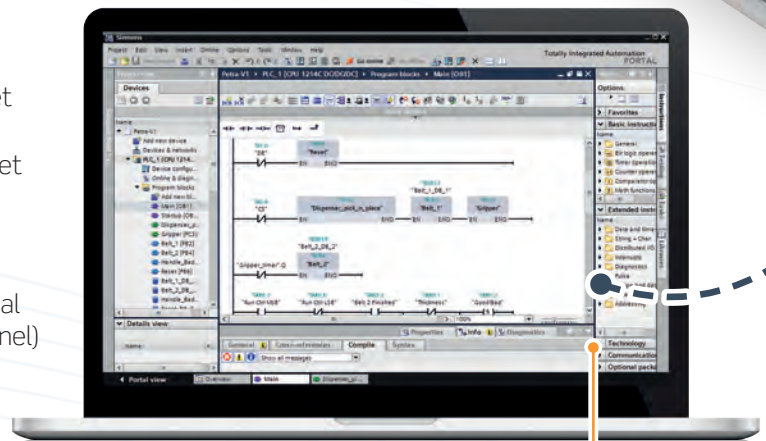
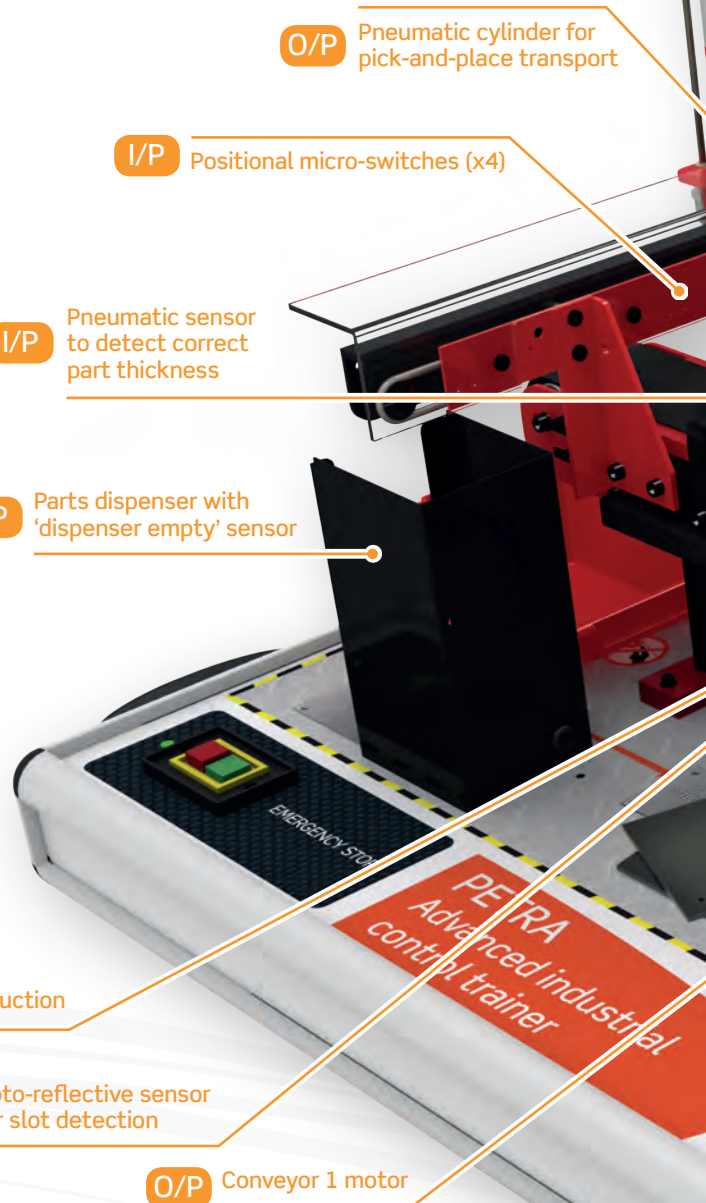

Siemens STEP 7 ladder logic software

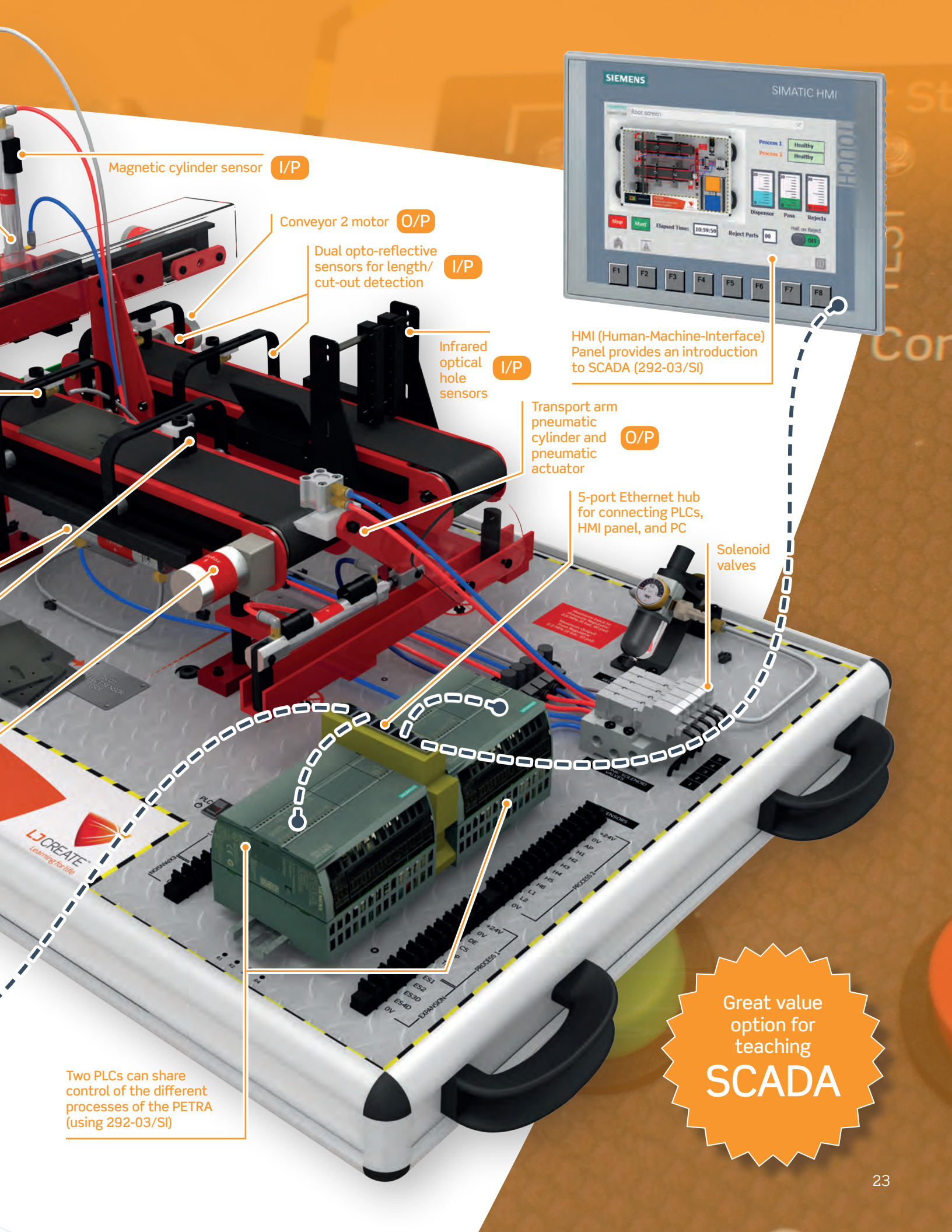

Magnetic cylinder sensor I/P

Conveyor 2 motor O/P

Dual opto-reflective sensors for length/cut-out detection I/P

Infrared optical hole sensors I/P

Transport arm pneumatic cylinder and pneumatic actuator O/P

5-port Ethernet hub for connecting PLCs, HMI panel, and PC

Solenoid valves

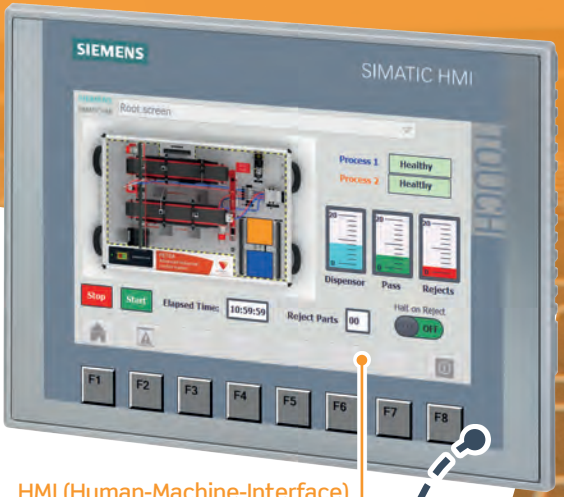

HMI (Human-Machine-Interface) Panel provides an introduction to SCADA (292-03/SI)



Two PLCs can share control of the different processes of the PETRA (using 292-03/SI)

Great value option for teaching SCADA

Industrial Controls & PLCs Hardware

Transducers, Instrumentation and Control Trainer (217-50)

The Transducers, Instrumentation and Control Trainer introduces students to input sensors, output actuators, signal conditioning circuits and display devices through a wide range of hands-on practical activities.

Typical practical tasks and topics include:

- Electronic switch
- Positional resistance transducers
- Wheatstone bridge measurements
- Temperature sensors
- Light measurement
- Environmental measurement
- Rotational speed or position measurement

Order as:

- 217-50 Transducers, Instrumentation and Control Trainer

Also available:

- 217-00 Transducers, Instrumentation and Control Teaching Set (Includes 217-50 and 217-60)

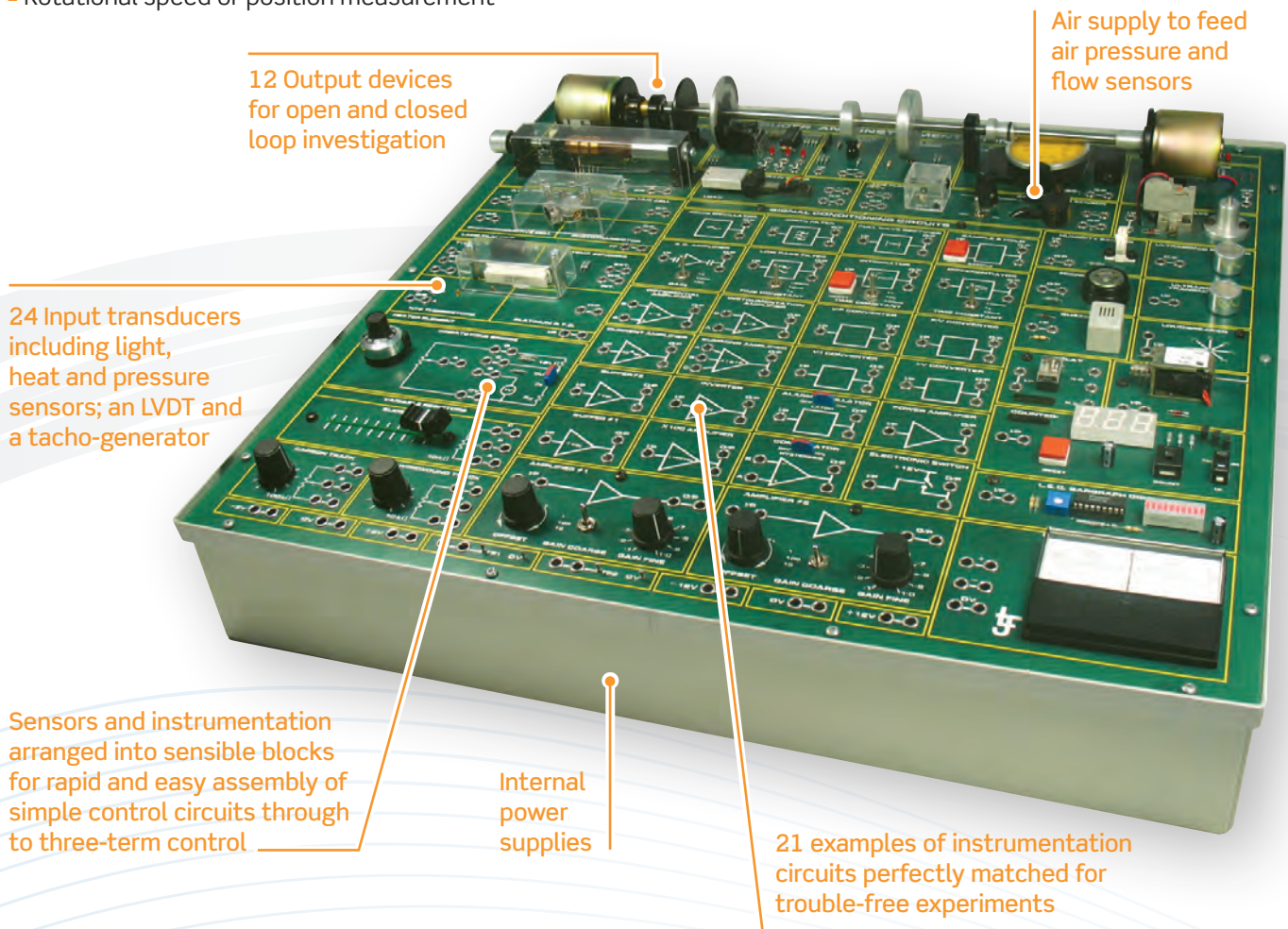

Data Acquisition of Control Systems (217-60)

This package can be used to introduce students to the monitoring and recording of control system performance using a PC.

It is designed to provide an extension to work carried out using our Transducers, Instrumentation and Control Trainer.

A Virtual Instrument Unit allows a PC to act as the following test instruments:

- Two digital voltmeters
- Dual trace digital storage oscilloscope
- Spectrum analyzer
- Signal generator
- Data logger and grapher

Order as:

- 217-60 Data Acquisition of Control Systems (Requires a 217-50)



Analog and Digital Motor Control Teaching Set (207-00)

This system provides the complete solution to teaching analog and digital motor control. The heart of the system is a mechanical unit which produces repeatable, text-book results every time.

Order as:

- 207-00 Analog and Digital Motor Control Teaching Set

Teaching set includes:

- 207-02 Virtual Control Laboratory
- 207-03 Command Potentiometer
- 207-04 PID Controller Module
- 207-05 4mm Connection Lead Set
- 207-15 D.C. Motor Control Module
- 207-40 Power Supply Unit

Virtual control laboratory



Variable eddy current brake

Analog feedback via a tacho-generator and precision potentiometer

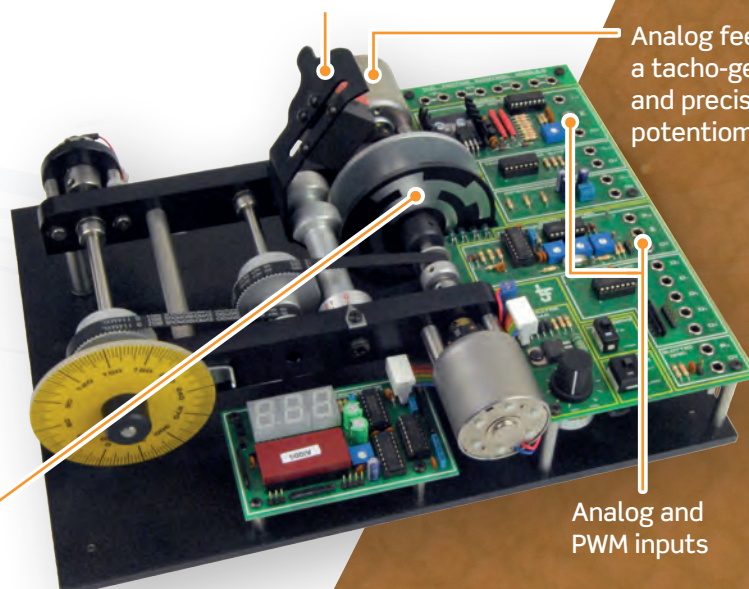

Digital feedback from Gray code and slotted discs

Analog and PWM inputs

Process Control Hardware

Process Control Technology Benchtop Trainer (208-10)

This fully-integrated, self-contained bench top apparatus consists of a process module, and a control console with a built-in power supply.

Windows-based software with full control and data acquisition is included. A number of experiments in process control are included covering: Flow, Level, Pressure, and Temperature.

The console has a mimic of the process module on the front and includes fault switches and test points from all of the transducers.

Order as:

- 208-10 Process Control Technology Benchtop Trainer

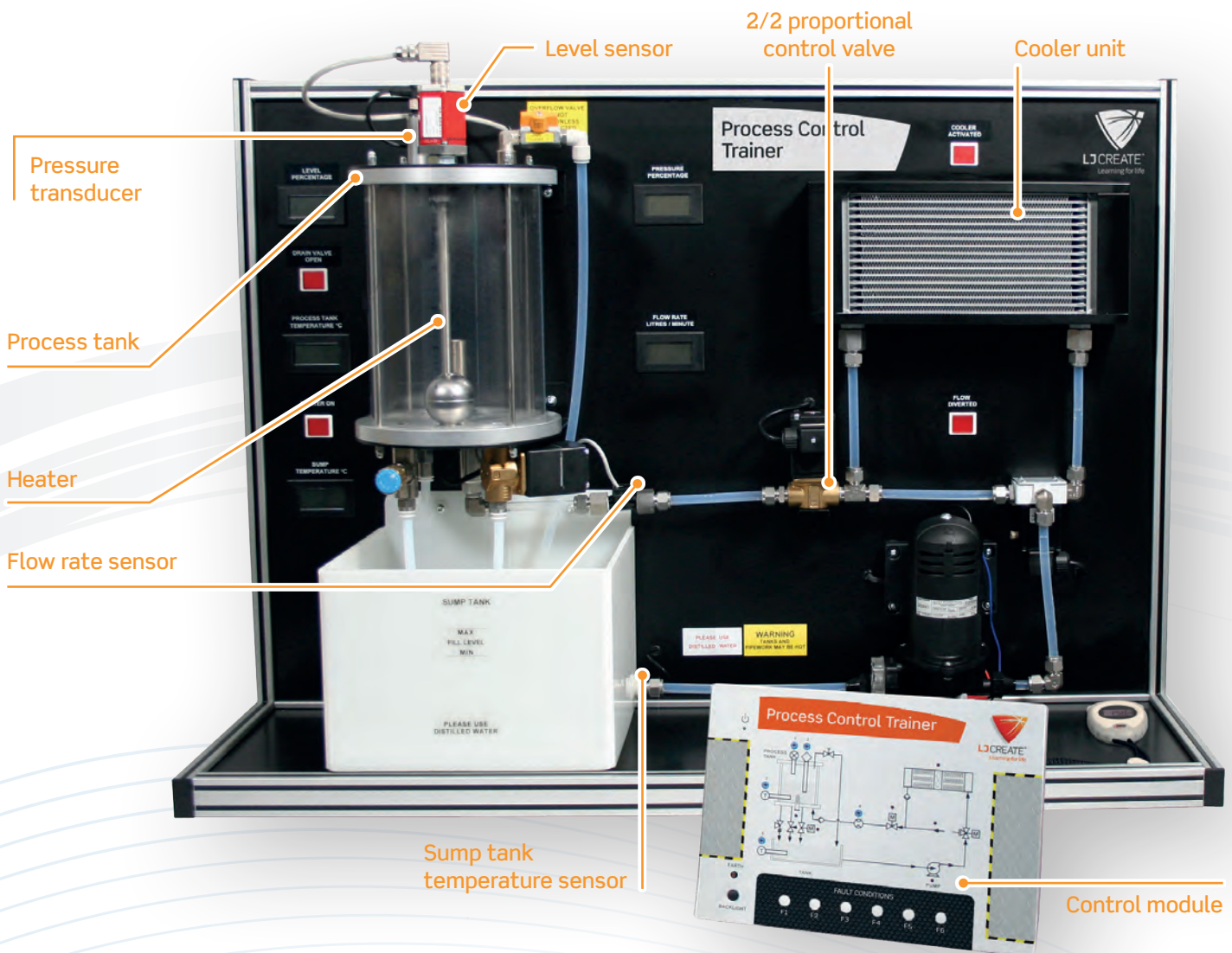

Process Control Technology Flow Module (208-01)

This trainer allows users to see actual flow rate in a self-contained system. A pump connects through PVC pipes - to a flow sensor, a valve, and to a rotameter.

The study of flow control and monitoring in a system can be performed through the supplied software, which has PID control with a graphical interface for data analysis.

Order as:

- 208-01 Process Control Technology Flow Module



Process Control Technology Pressure Module (208-03)

This trainer enables the study of the principles in pressure control and monitoring in a pressurized system.

The system consists of a compressor connected to a reservoir tank, a regulator valve, a pressure sensor, a needle valve to add a disturbance, and a pressure gauge to indicate the pressure in the system.

Order as:

- 208-03 Process Control Technology Pressure Module

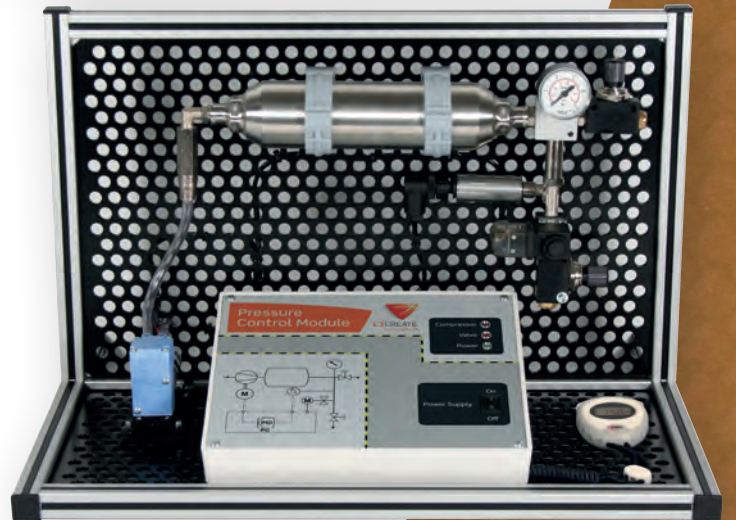

Process Control Technology Temperature Module (208-04)

This trainer enables the study of the principles in temperature control and monitoring in a self-contained system.

The control module is contained on the unit and has a mimic of the systems, and LED indication. The trainer can be controlled through the graphical-based software supplied with the unit providing PID control.

Order as:

- 208-04 Process Control Technology Temperature Module

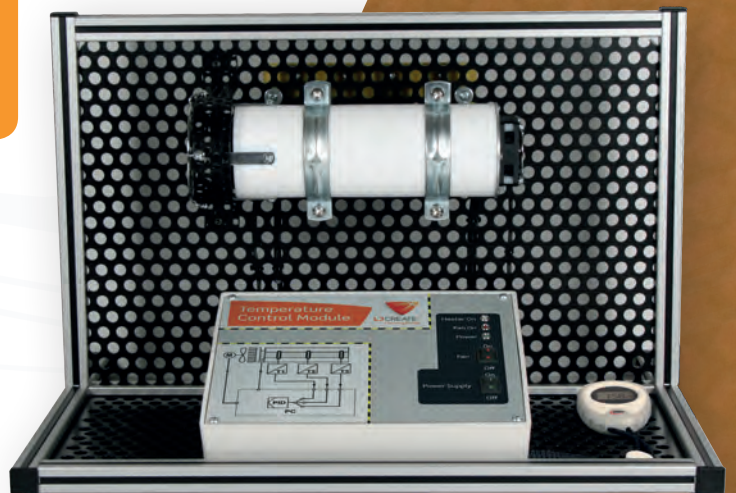

Engineering Design Hardware

Engineering Construction Kit (220-01)

The Engineering Construction Kit includes simple, yet sophisticated, programming software to allow students to design flowchart programs to bring their models to life.

The Engineering Construction Kit is used to help students develop solutions to a range of practical real-world problem-solving tasks and activities within a classroom or lab environment.

Order as:

- 220-01 Engineering Construction Kit

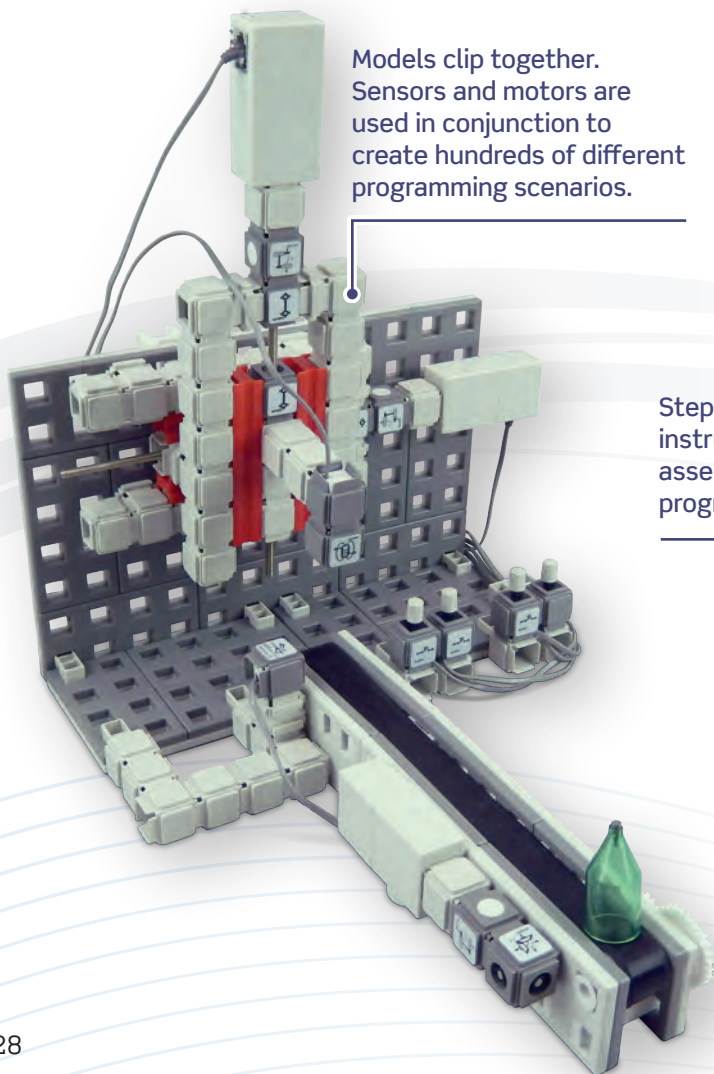

Step-by-step instructions for assembly and programming

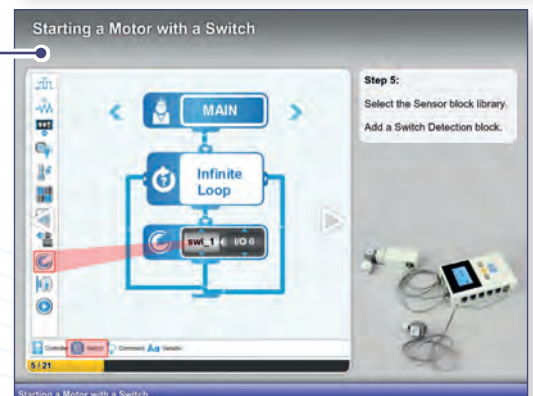
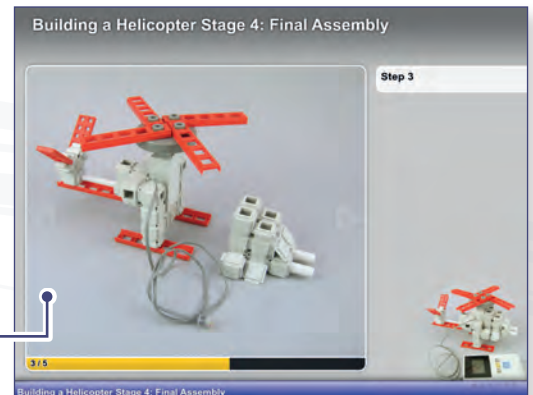

Educational Robotics Invention Kit - ERIK (250-01)

The Educational Robotics Invention Kit provides students with an environment that motivates them to learn abstract computer science concepts in a bid to solve practical problems with physical outcomes.

The combination of engineering and programming creates a dynamic environment that helps students develop problem-solving skills that involve mathematics, engineering, science and logic.

Typical practical tasks and topics include:

- Languages, machines and computation
- Testing and debugging
- A series of open ended design projects to allow students to get creative

Order as:

- 250-01 Educational Robotics Invention Kit

Block libraries

Coding window for creating programs in standard C language

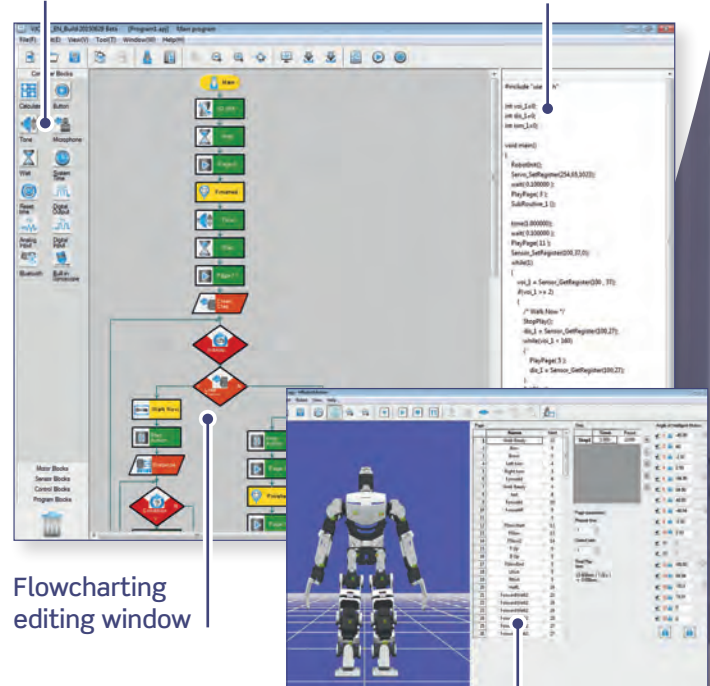

Flowcharting editing window

Robot motion editing

Intelligent Servo Motors with speed and position control. In joint mode they can rotate 300° or they can be set to continuous rotation with speed control for wheels etc.

Controller includes Bluetooth communication to handset and a gyroscope which measures ground angle in three dimensions

Clip-together construction parts

Sensor block measures side and front distance, light intensity and sound. It can differentiate between black and white.

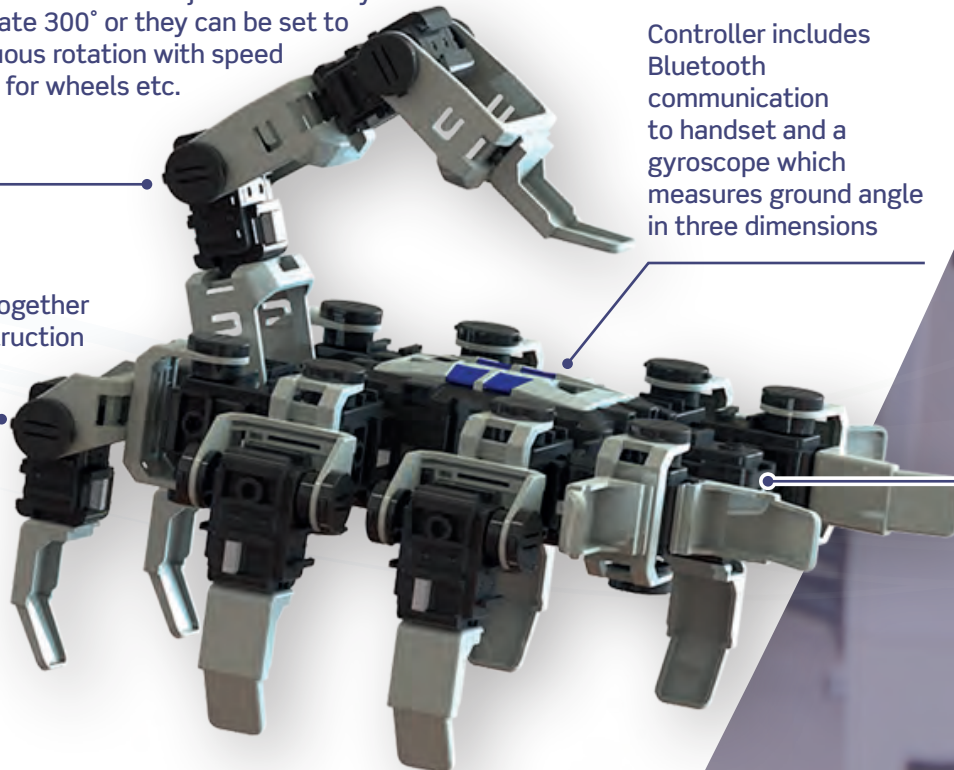

→ Innovative Spaces

Skills and Knowledge Lessons for your Learning Space

Cost effective hands-on laboratory space with SKILLS lessons delivered via digital content library.

Anytime, anywhere knowledge delivery - via whole-class or individualized instruction.

Investigate hydraulic systems and components in a practical way using an all-in-one desktop trainer

The Robotics Trainer offers a classroom-based resource for practical investigation of the technology and engineering behind modern automated systems

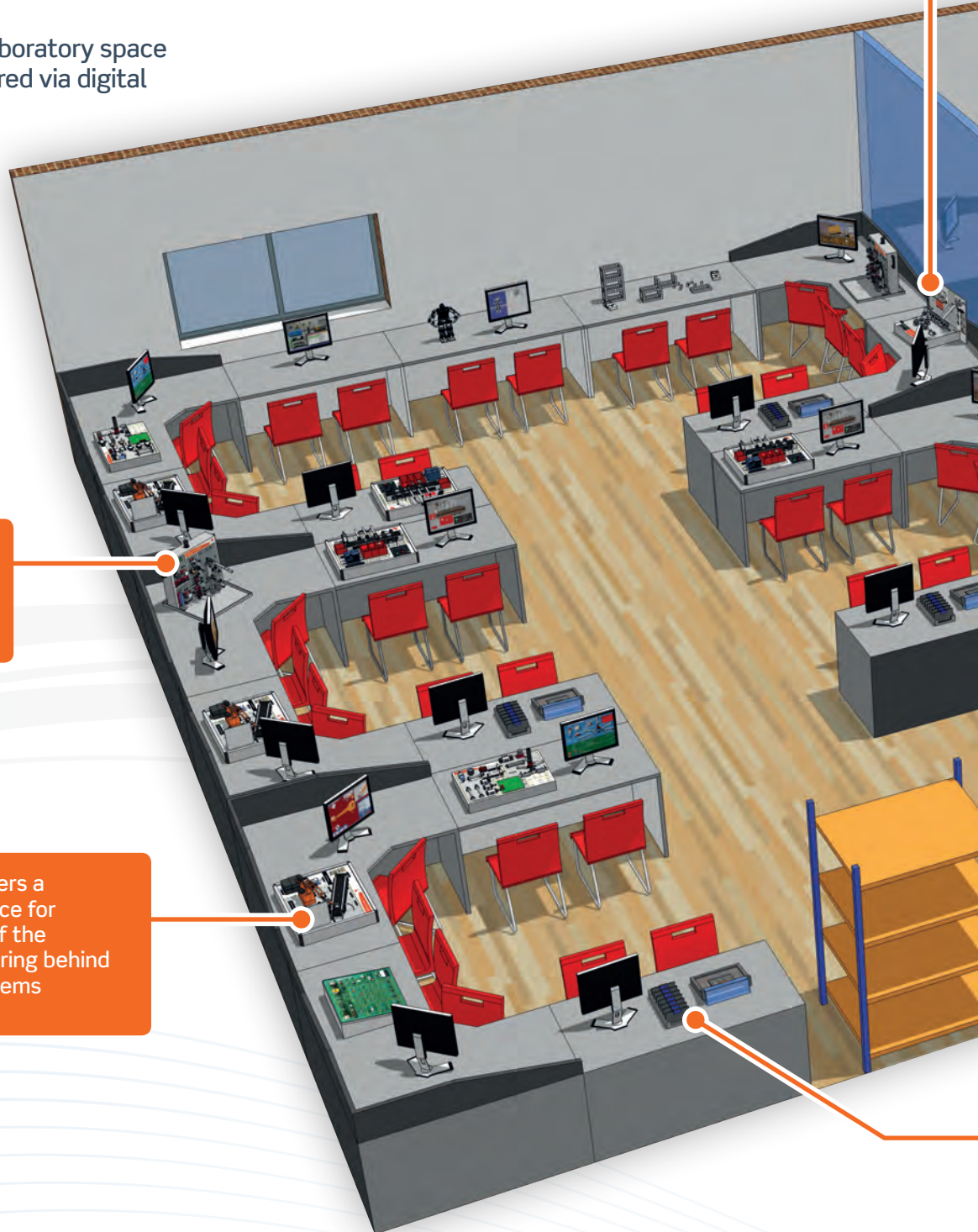

Students perform practical investigations of a variety of fundamental mechanical systems



Teacher presentation zone for foundational knowledge lessons

Interchangeable circuit cards allow coverage of a wide range of electronics principles and applications

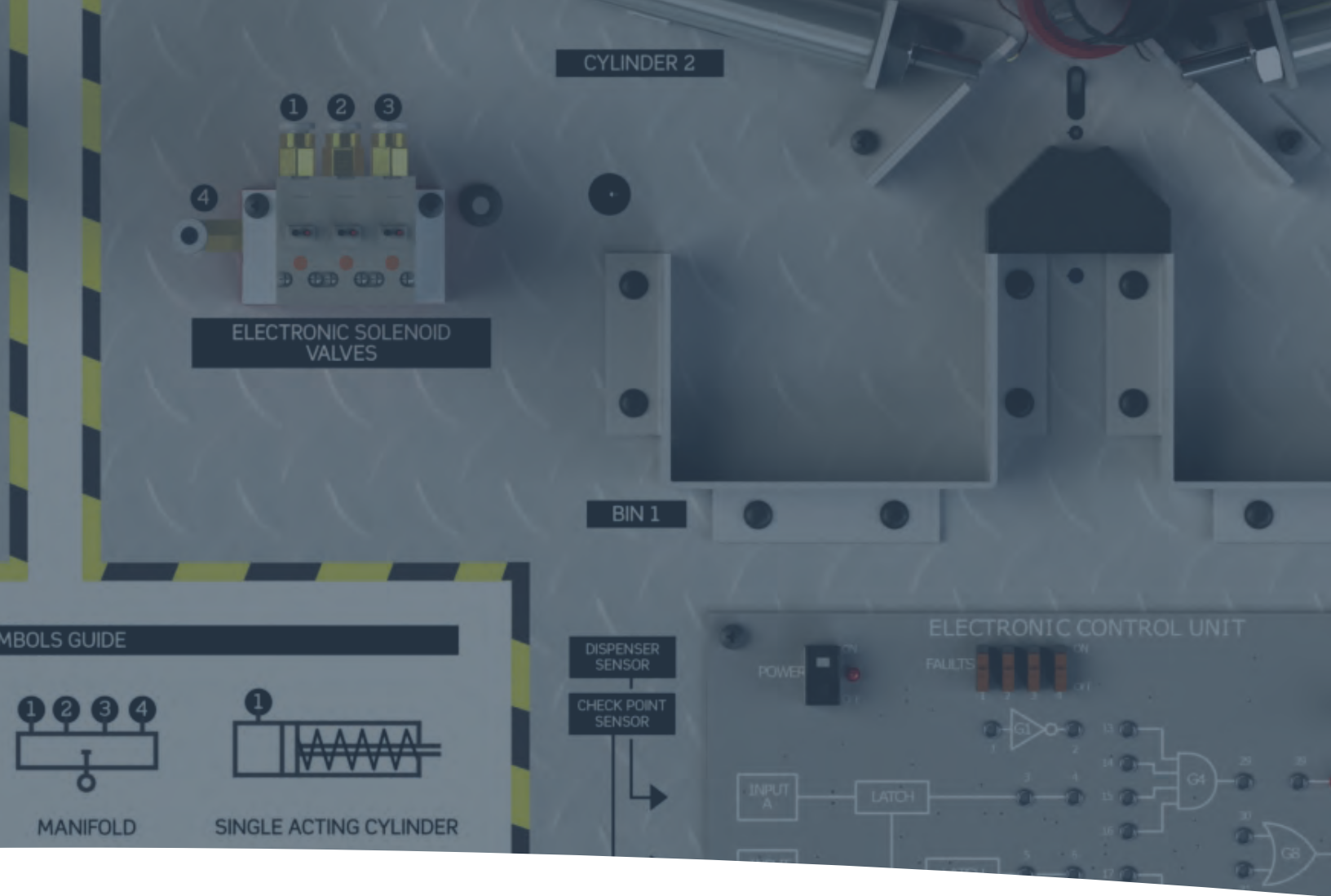

For more information on our range of learning resources, please contact:

LJ Create

6900 Tavistock Lakes Blvd,
Suite 400
Orlando, FL 32827

T: 1-800-237-3482
E: info@ljcreate.com

ljcreate.com

LJ Create recognizes all product names used in this document as trademarks or registered trademarks of their respective holders. We reserve the right to change the contents of any module or program. For the latest information on any of our products, please visit our website.