

Creating skilled automotive engineers

Working with STEM

Truck Maintenance Training

Aligned to NATEF

Knowledge and Skills Lessons



LJCREATE™
Learning for life

Working with STEM

→ **AutoLab**

Medium/Heavy
Duty Truck



→ Welcome

We're LJ Create, education specialists since 1979

Since 1979 we have been providing award winning, world-class active learning solutions for technical education.

Today we create complete systems combining digital lesson libraries and tailor-made hardware kits that deliver **innovative, inspiring learning** in science, technology, automotive, and engineering.

At LJ Create our mission is to enable learners throughout the world to achieve their full potential in a wide range of science and engineering areas by providing innovative teaching solutions for schools and further education.

AutoLab has been one of our flagship learning programs since 2001. Now we are relaunching AutoLab alongside **Working with STEM**, our brand-new cloud-based library of over 4,300 vocational lessons.

Our **Medium/Heavy Duty Truck Trainers** are an important element of the AutoLab program, forming part of the **complete system of hardware and software for teaching automotive repair skills to NATEF standards**.

Alternatively, our high-tech trainers could make a fantastic addition to an existing program in your high school or college.

Our skilled team of curriculum developers are automotive specialists; they produce **up-to-date lesson plans, teaching materials and assessments** to make teaching and documentation easy.

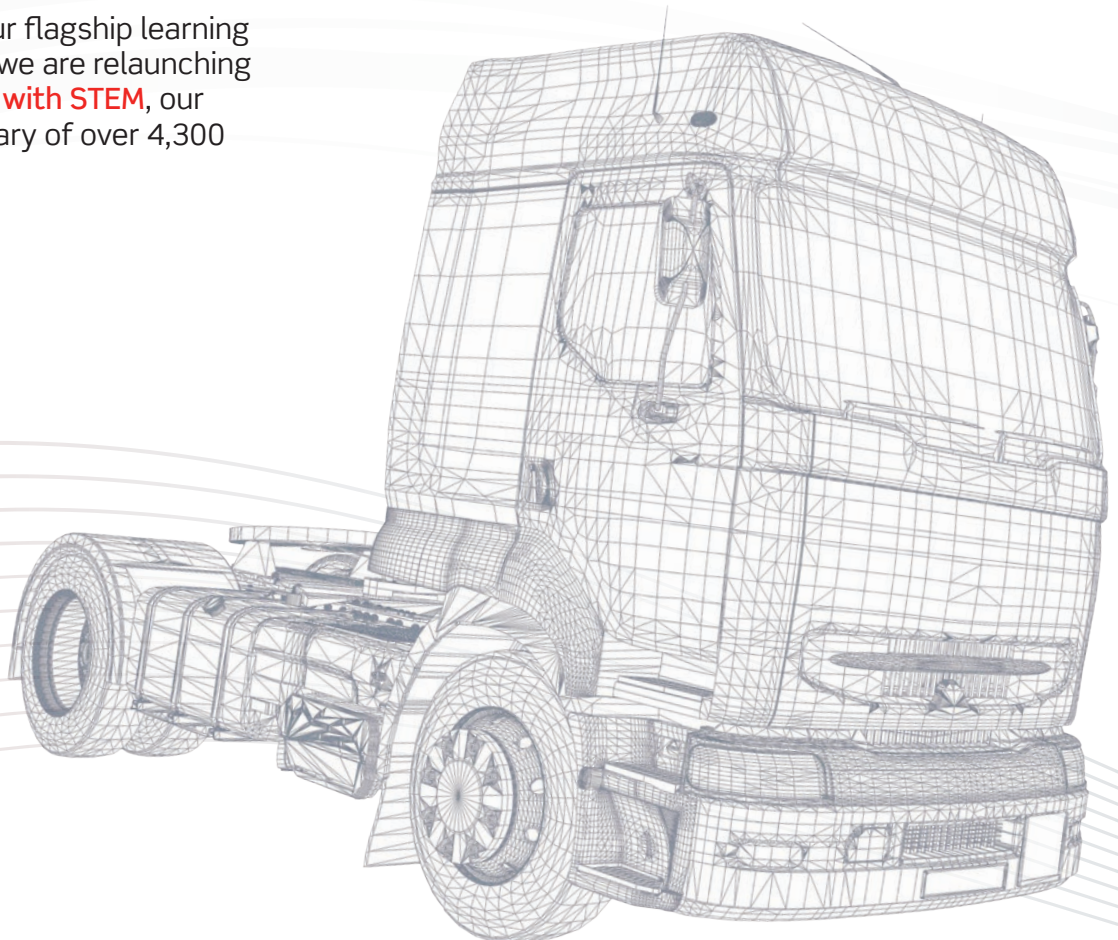

Contents

AutoLab and NATEF	4 - 5
Knowledge Lessons	6
Skills Lessons	7
Medium/Heavy Vehicle Hardware	8 - 17
- Vehicle Rigs	8 - 11
- Sectioned Trainers	12 - 13
- Autotronics Panel Trainers	14 - 15
- Autotronics Circuit Trainers	16 - 17
Light Vehicle Examples	18
Create your own AutoLab	19



→ AutoLab and NATEF

AutoLab and NATEF: your learning journey

Inspired by NATEF's specific tasks and learning outcomes (2014), the **AutoLab learning journey** equips your students with the skills, knowledge, and experience they need to become successful medium/heavy duty truck technicians.

AutoLab guides students through each lesson in the task, with a series of **Knowledge Lessons** in the form of presentations, simulations and investigations to reinforce a theoretical

understanding of the subject area. At this point, you can confirm your students' knowledge with a short assessment.

Once students are confident, they can move on to practical **Skills Lessons** in the classroom or shop, using our operational rigs, panel trainers, circuit board trainers, and sectioned trainers. Again, you can confirm your students' knowledge with a short assessment.

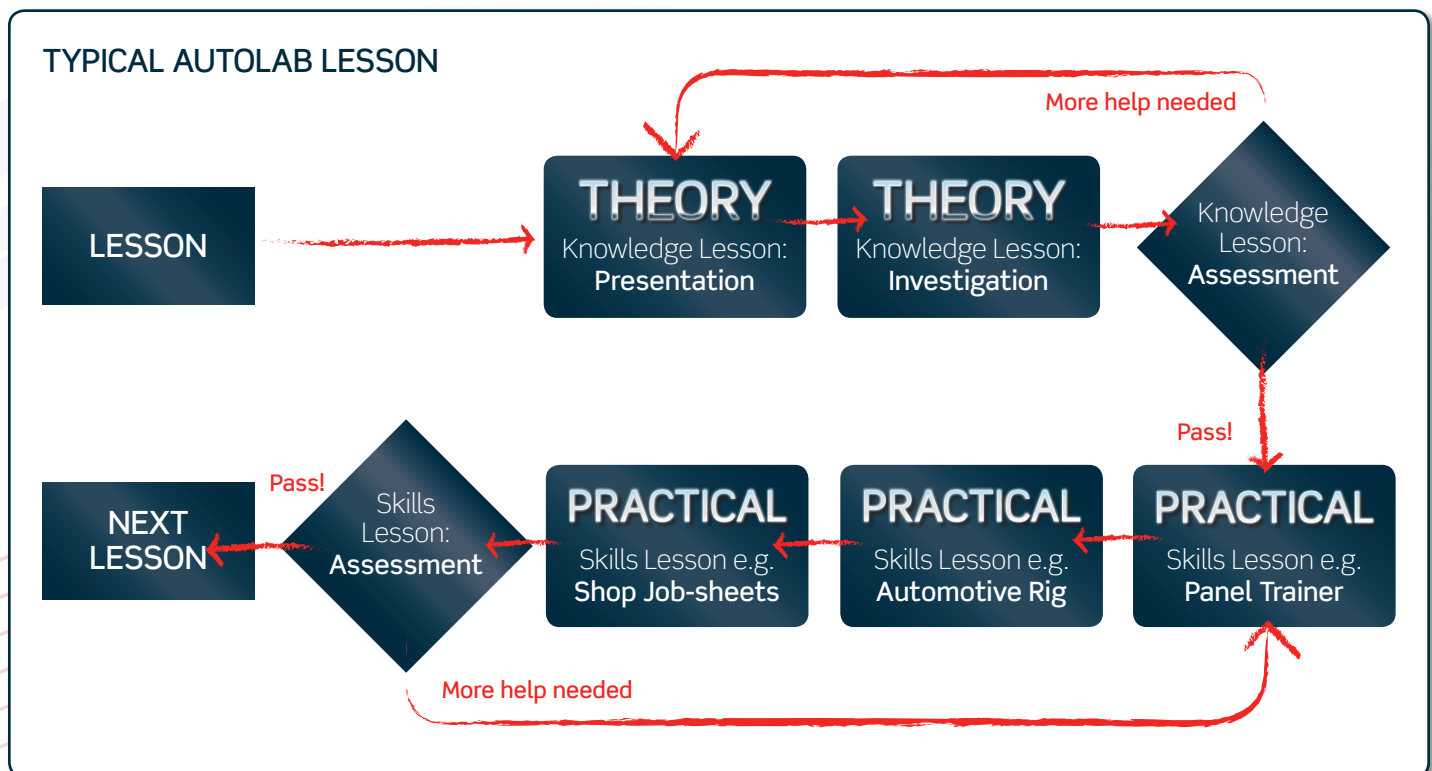

Key:

- A = We provide content to cover all tasks
- B = We provide content to cover most tasks
- C = We cover all tasks using automotive content
- D = We provide content for half the tasks
- E = We provide supporting content for this area

		776-01 Diesel Engine Trainer	779-01/6C Sectioned Engine	758-01 Engine Man. Trainer	788-01 Diesel Man. Trainer	780-01 Sectioned Truck Gear.	786-01 4WD Sectioned Gear.	786-02 4WD Sectioned Drive.	787-01 Sectioned Clutch	781-01 Sectioned Rear Axle	785-01 Live Front Axle	778-01 Air Brake Trainer	778-02 Air Brake with ABS	778-03 Air Brake with EBS	763-01 Disc and Drum Brake	755-01 ABS Panel Trainer	764-01 Steer. and Susp. Train.	777-01 Electronic Air Susp.	700-10 Auto Electronics Train.	770-02 24V Electrical Trainer	757-01 HV Electrics Panel	701-03 Heavy Vehicle Lighting	766-01 Air Con. Trainer	754-01 Air Con. Panel	ALB2-AL Auto Repair Library	Content Coverage				
100% ALIGNED	SUPPLEMENTAL TASKS	Shop and Personal Safety																									●	A		
		Tools and Equipment																											●	A
		Preparing Vehicle for Service																											●	A
		Preparing Vehicle for Customer																											●	A
		Personal Standards																											●	A
		Work Habits/Ethic																											●	A
70% ALIGNED	DIESEL ENGINES	General	●																									●	B	
		Cylinder Head and Valve Train		●																									●	B
		Engine Block		●																									●	B
		Lubrication Systems																											●	E
		Cooling System																											●	B
		Air Induction & Exhaust Systems																											●	D
		Fuel System Supply	●																										●	D
		Fuel System EFM			●	●																							●	B
Engine Brakes																											●	E		
75% AL.	DRIVE TRAIN	Clutch							●																			●	B	
		Transmission				●	●	●																					●	B
		Driveshaft and UJ						●																					●	E
		Drive Axle									●	●																	●	B
70% ALIGNED	BRAKES	Air Brakes								●	●	●	●															●	E	
		Mechanical/Foundation Brakes														●													●	E
		Parking Brakes														●													●	E
		Hydraulic Brakes														●													●	B
		Power Assist														●													●	B
		ABS											●	●		●													●	E
		Wheel Bearings																											●	E
80% ALGN.	STEERING AND SUSP.	Steering Systems										●	●					●										●	C	
		Suspension Systems																	●									●	E	
		Wheel Alignment																	●									●	B	
		Wheels and Tires																	●									●	E	
		Frame and Coupling Devices																	●									●	E	
95% ALIGNED	ELECTRICAL /ELECTRONIC	General Electrical Systems																		●								●	A	
		Battery																		●								●	A	
		Starting and Charging																		●								●	A	
		Lighting																		●		●						●	A	
		Gauges and Warning Devices																		●		●						●	D	
		Related Electrical Systems				●																●	●					●	B	
95% ALGN.	HVAC	HVAC Systems																						●	●			●	C	
		AC Components																						●	●			●	C	
		Heating and Engine Cooling																										●	C	
		Operating Systems																										●	C	
		Refrigerant Recovery																						●	●			●	C	
40% ALIGNED	HYDRAULICS	General System Operation																										●	E	
		Pumps																										●	E	
		Filtration																										●	E	
		Hoses																										●	E	
		Control Valves																										●	E	
		Actuators																										●	E	

→ Knowledge Lessons

The AutoLab digital library

The AutoLab **digital library** is a comprehensive resource for all the theory behind NATEF's specified subject areas. Students can access the library through an online portal; no specialist software or downloads are needed. An Internet connection and browser is all they require to access our collection of **Knowledge Lessons**.

Our Knowledge Lessons consist of **Presentations** for use in front of a class, or for students to refresh their knowledge individually; **Investigations** where students can put knowledge into practice with tasks and challenges; and **Assessments**, short quizzes with instant feedback so you can be confident that your students are ready to progress.

Presentations

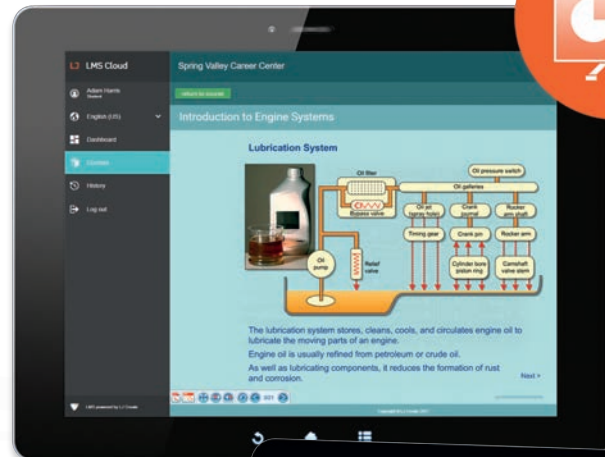

Investigations

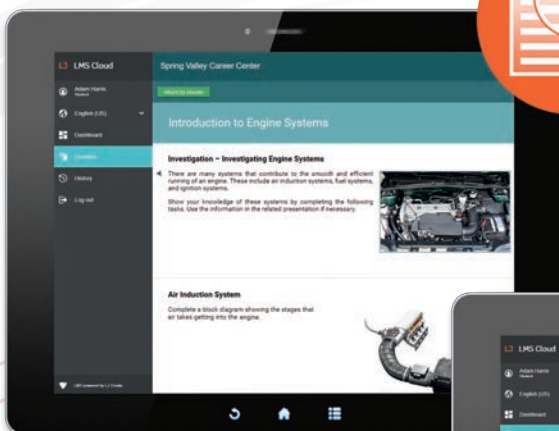

Assessments

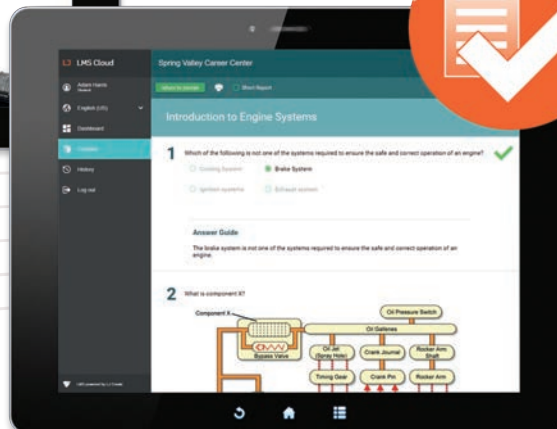

→ Skills Lessons

Guide your students from the classroom to the shop

Our **Skills Lessons** are also found in our AutoLab Digital Library, and consist of practical activities that can be undertaken on our range of automotive training equipment, as well as shop job sheets, and health and safety guidelines.

Our training equipment ranges from cut-away **sectioned trainers** that allow students to see what is happening inside working components, to desktop **autotronics trainers** that simulate complex automotive systems, through to fully-functioning **operational auto rigs and vehicle trainers**.

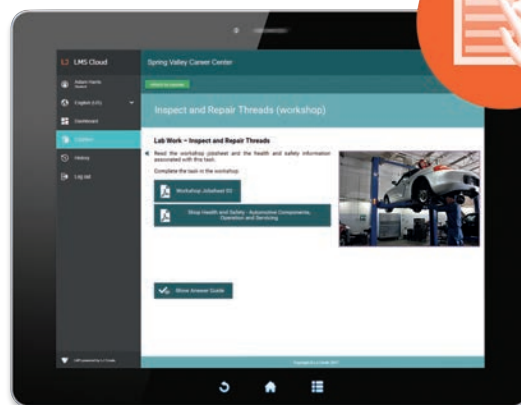

Support and Standards

It's easy to see where our lessons align with NATEF, just use the Standards menu on the right to filter lessons by NATEF level, subject and task.

We also include academic support in the science and math concepts relating to each subject area. Just click on the Support tab for supporting lessons.



Medium/Heavy Vehicle Rigs Hardware

6-Cylinder Truck Diesel Engine (Common Rail) Trainer (776-01/6C)

This trainer provides the instructor with a complete working 6-cylinder heavy vehicle diesel engine with a Bosch EDC engine management system and high-pressure common rail fuel injection system. The trainer is mounted on a moveable, heavy-duty steel frame.

Trainer enables demonstration of the following:

- The position and mounting of all engine components
- Engine management system fundamentals
- Sensor and actuator components
- Real faults can be inserted allowing for demonstration of diagnostic techniques

Order as:

- 776-01/6C 6-Cylinder Truck Diesel Engine (Common Rail) Trainer

Also available:

- 776-01 4-Cylinder Truck Diesel Engine (Common Rail) Trainer
- 776-04/6C 6-Cylinder Truck Diesel Engine (Tier 4/EPA 2010) Trainer

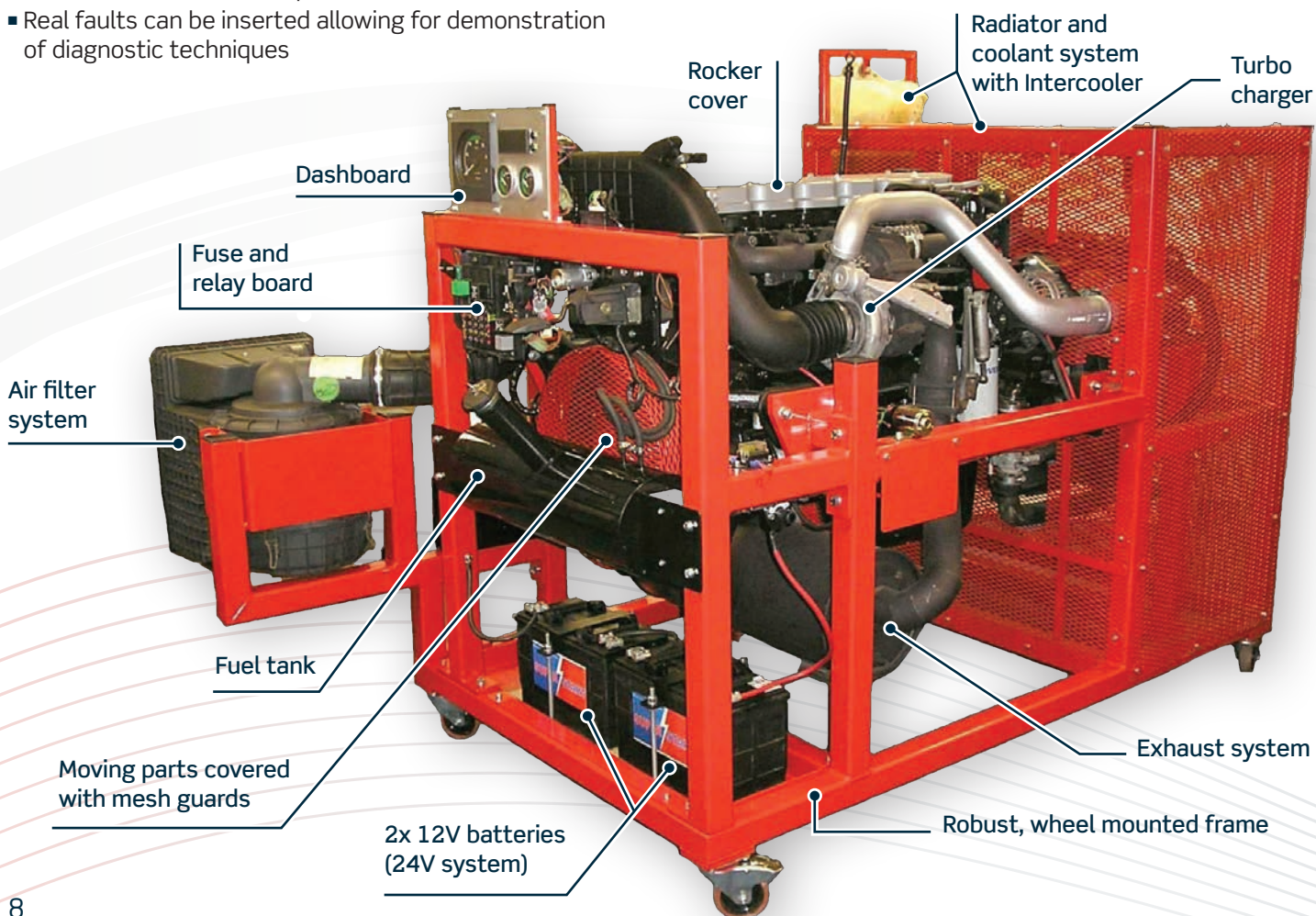

Sectioned Truck Diesel Engine (6-Cylinder) Trainer (779-01/6C)

This trainer provides the instructor with a fully sectioned 6-cylinder truck diesel engine for group or whole-class demonstration. The trainer is mounted on a self-contained steel frame and base plate, complete with castors.

Order as:

- 779-01/6C Sectioned Truck Diesel Engine (6-Cylinder) Trainer

Also available:

- 779-01 Sectioned Truck Diesel Engine (4-Cylinder) Trainer



Electronic Controlled Air Suspension Trainer (777-01)

This trainer provides the instructor with a fully operational Electronically Controlled Air Suspension (ECAS) trainer, manufactured using original components. It is based on a DAF ECAS III 4x2 truck.

The trainer is mounted on a self-contained steel frame and base plate, complete with castors.

Order as:

- 777-01 Electronic Controlled Air Suspension Trainer



Disc and Drum Braking System Trainer (763-01)

This real component-based trainer provides students and instructors with the opportunity to demonstrate and investigate the operation of a typical automotive braking system.

The trainer is designed to allow access to disc and drum brake components, as well as providing the opportunity to understand the operation of the hydraulic circuit.

Order as:

- 763-01 Disc and Drum Braking System Trainer



➔ Medium/Heavy Vehicle Rigs Hardware

Steering and Suspension System Trainer (764-01)

This real component trainer provides the instructor with a working steering and suspension system for group or whole-class demonstration.

This includes all the individual components of the system presented on a moveable, steel frame so that each component can be clearly identified.

Typical practical demonstrations include:

- Disassemble, inspect, and reassemble rack and pinion steering gear
- Inspect steering shaft universal joint, flexible coupling, collapsible column, lock cylinder mechanism
- Inspect power steering fluid levels and condition

Order as:

- 764-01 Steering and Suspension System Trainer



Air-Conditioning System Trainer

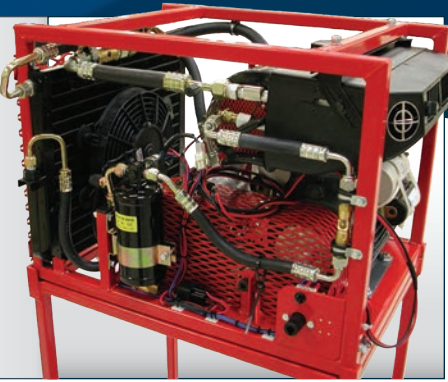

Order as: 766-01

Live Front Axle with Air Disc Brake Assembly



Order as: 785-01

24 Volt Electrical System Trainer



Order as: 770-02

Disc Air Brake Trainer



Order as: 778-04

Air Brake Tractor/Trailer System Trainer (778-01)

This comprehensive, panel-mounted system provides a fully operational 2-line air brake system, as fitted to a typical heavy vehicle tractor and trailer unit. The trainer features quick-fit connectors over the whole board.

Order as:

- 778-01 Air Brake Tractor/Trailer System Trainer

Also available:

- 778-02 Air Brake Tractor/Trailer System Trainer with ABS
- 778-03 Air Brake Tractor/Trailer System Trainer with EBS

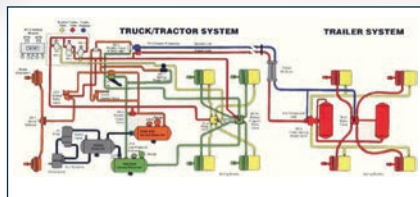
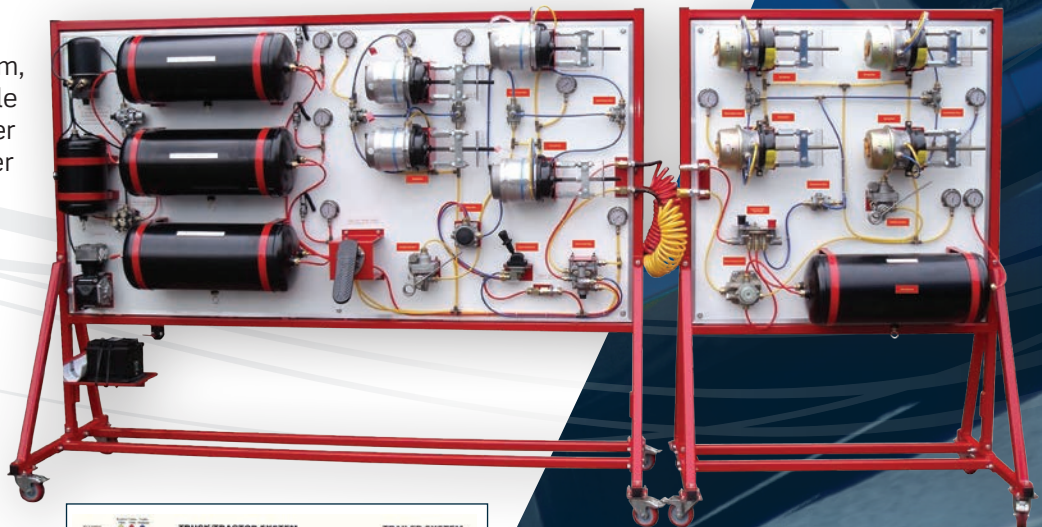

US schematic

Medium/Heavy Sectioned Trainers Hardware

Sectioned Truck Gearbox Trainer (780-01)

This trainer provides the instructor with a fully sectioned truck gearbox for group or whole-class demonstration. The trainer is mounted on a self-contained steel frame and base plate, complete with castors.

Order as:

- 780-01 Sectioned Truck Gearbox Trainer

Typical practical tasks and topics include:

- Identification of main gearbox mechanical components
- Operation of gearbox and reduction components
- Identification of crawler range components
- Identification of synchro hubs

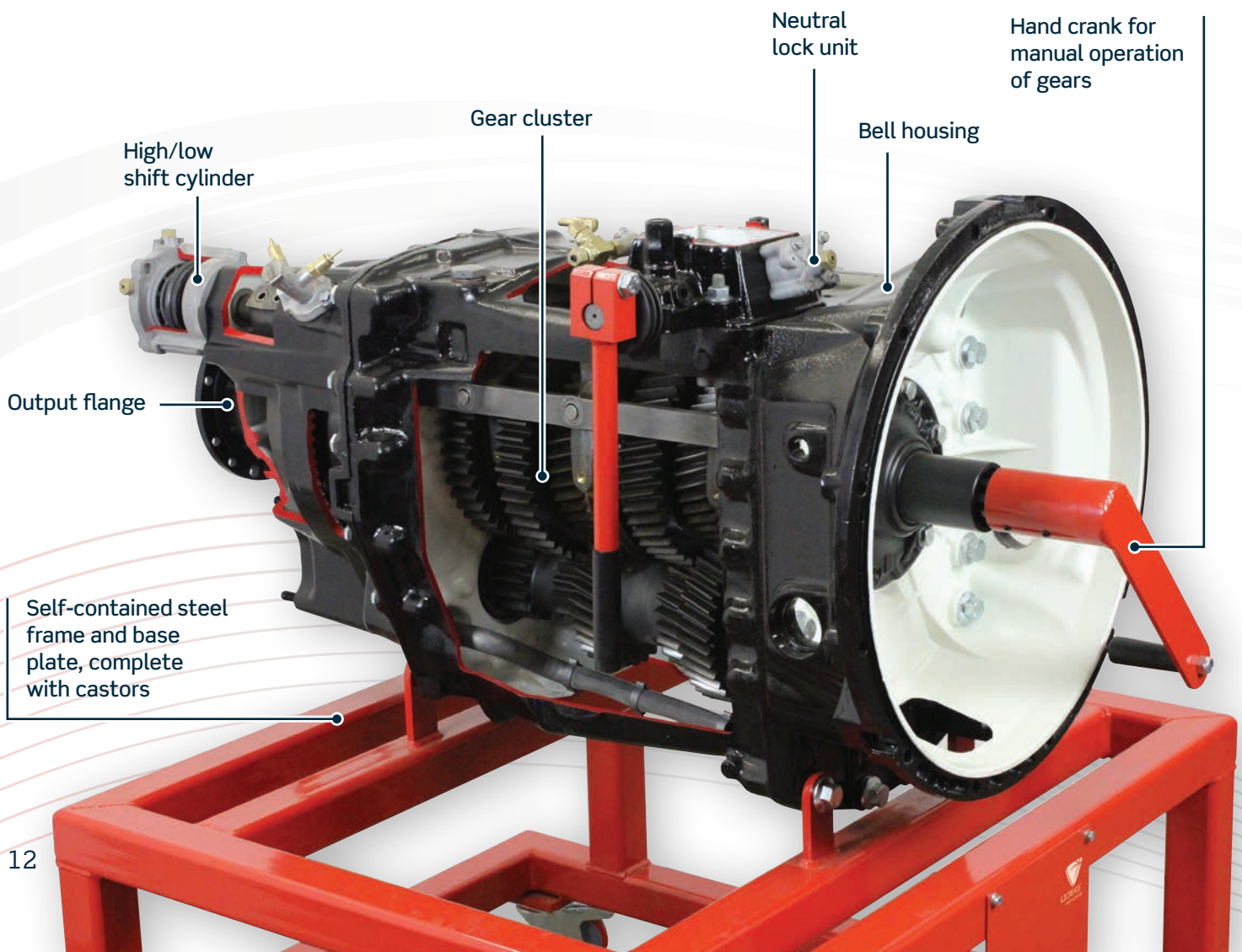

Sectioned Truck Rear Axle (with Reduction Hubs) Trainer (781-01)

This trainer provides the instructor with a fully sectioned truck rear axle, for group or whole-class demonstration. The trainer is mounted on a self-contained steel frame and base plate, complete with castors.

Order as:

- 781-01 Sectioned Truck Rear Axle (with Reduction Hubs) Trainer



Four Wheel Drive Sectioned Gearbox



Order as: 786-01

Sectioned Heavy Vehicle Clutch



Order as:
787-01

Four Wheel Drive Sectioned Drivetrain

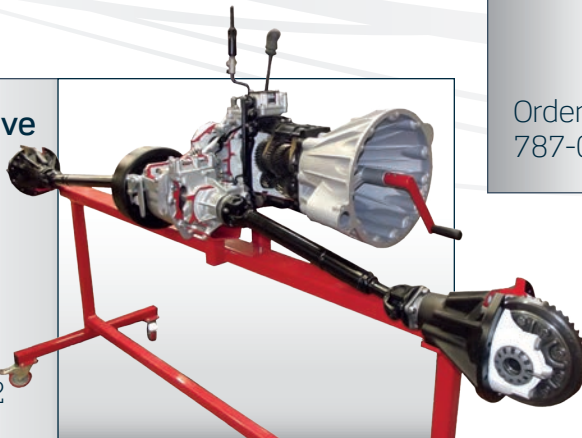

Order as: 786-02

Medium/Heavy Panel Trainers Hardware

Heavy Vehicle Electrical Systems Panel Trainer (757-01)

This trainer provides students and instructors with the opportunity to demonstrate, investigate, and fault-find a simulation of typical diesel electrical systems.

The trainer is designed to allow access to a variety of test points for vehicle electrical components, as well as provide an understanding of the overall system layout and configuration.

Order as:

- 757-01 Heavy Vehicle Electrical Systems Panel Trainer

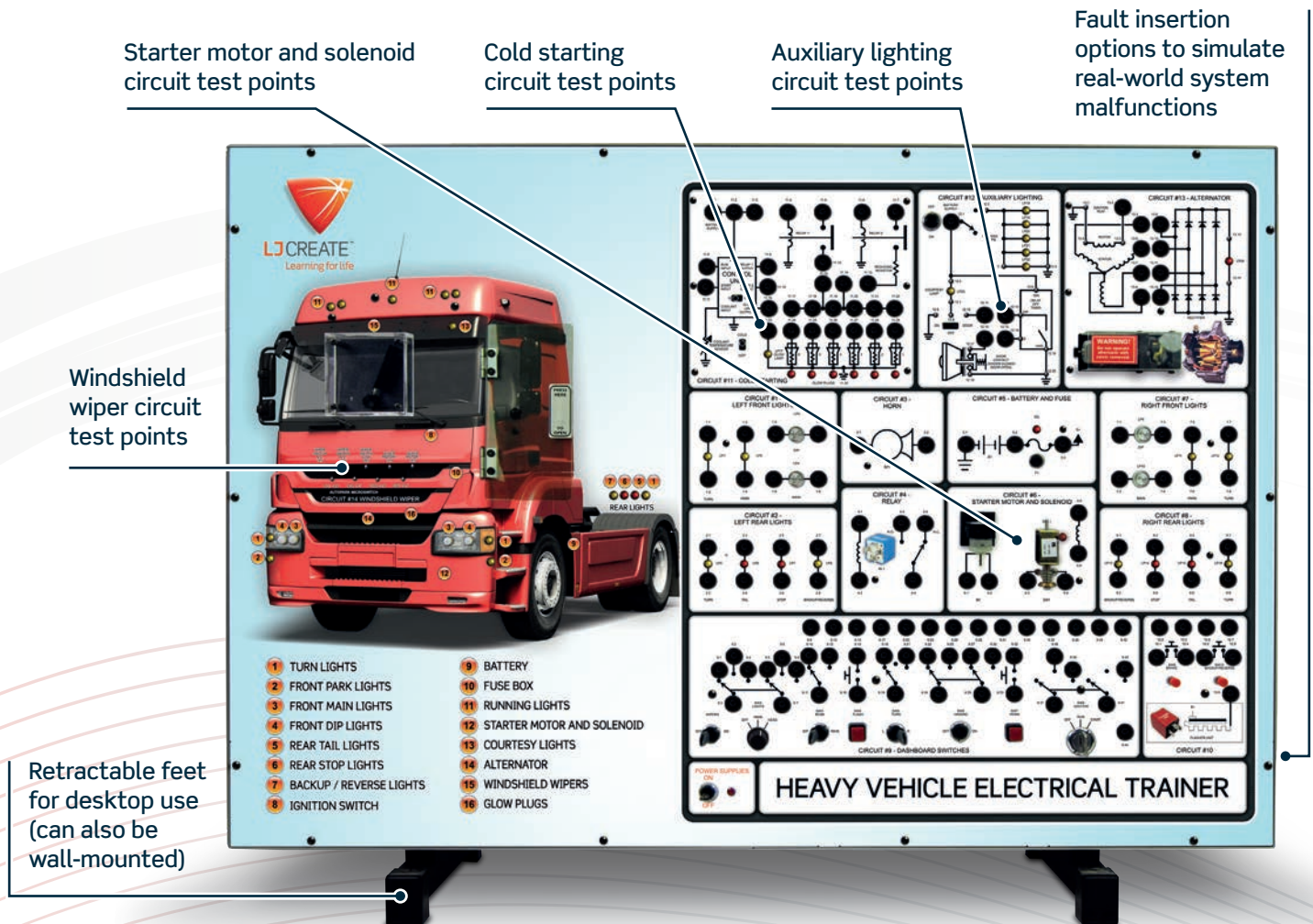

Air Conditioning Systems Panel Trainer (754-01)

This trainer provides students and instructors with the opportunity to demonstrate, investigate, and fault-find a simulation of a typical automotive air conditioning system.

The trainer is designed to allow access to controls for the vacuum system, electrical system and recharging station, as well as provide an understanding of the overall system layout and configuration.

Order as:

- 754-01 Air Conditioning Systems Panel Trainer

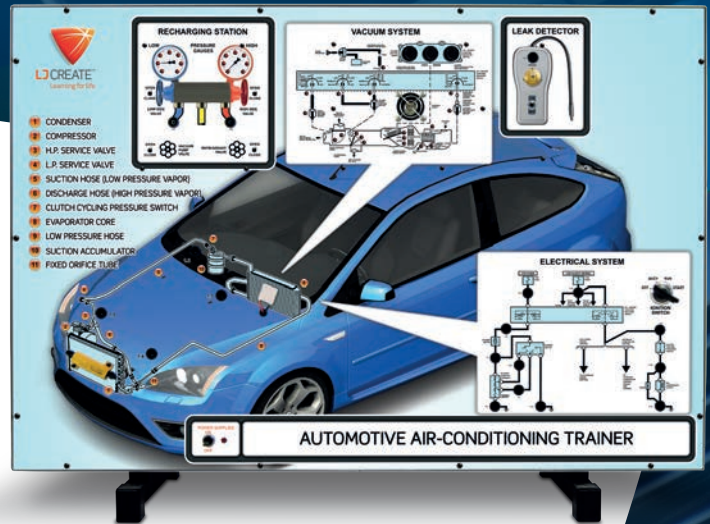

Anti-Lock Braking Systems Panel Trainer (755-01)

This trainer provides students and instructors with the opportunity to demonstrate, investigate, and fault-find a simulation of a typical 4-wheel anti-lock braking system.

The trainer is designed to demonstrate ABS hydraulic and electrical system operation, as well as provide the ability to simulate changes in road conditions that impact ABS operation.

Order as:

- 755-01 Anti-Lock Braking Systems Panel Trainer



Diesel Engine Management Systems Panel Trainer (758-01)

This trainer provides students and instructors with the opportunity to demonstrate, investigate, and fault-find a simulation of typical diesel engine management systems.

The trainer is designed to allow access to a variety of test points for vehicle electrical components, as well as provide an understanding of the overall system layout and configuration.

Order as:

- 758-01 Diesel Engine Management Systems Panel Trainer

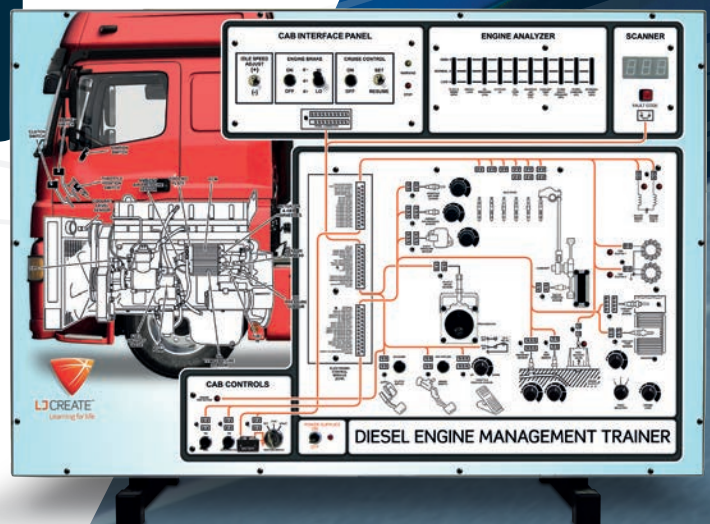

Medium/Heavy Circuit Trainers Hardware

Auto Electronics Trainer (700-10)

This hands-on learning resource allows students to build a variety of introductory automotive electronic circuits using a range of on-board and carrier-mounted components. Students are set tasks that encourage them to explore circuits practically to help develop their understanding of electrical components, circuits, and systems.

Typical practical tasks and topics include:

- Measure and construct simple circuits
- Investigate the operation of battery, fuse, switch and lamp components
- Ohm's Law and resistance
- Switches in series and parallel

Order as:

- 700-10 Auto Electronics Trainer

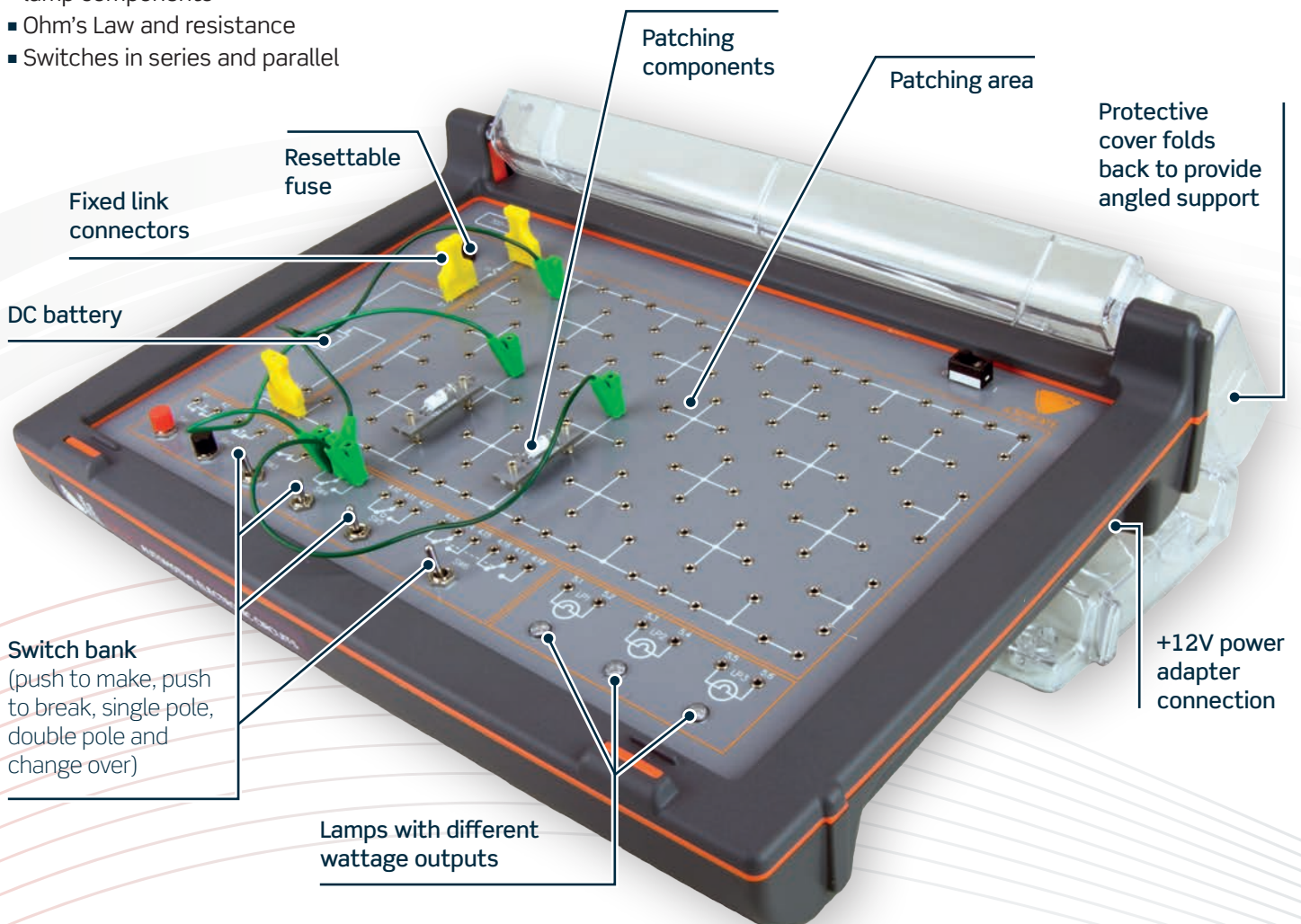

Heavy Vehicle Lighting Circuits Trainer (701-03)

Typical practical tasks and topics include:

- CAN bus lighting systems and CAN signals
- CAN control of lighting circuits: headlamp, brake, reverse, dipped beams, hazard warning lights, direction indicators, automatic lighting
- Finding and diagnosing CAN lighting faults

Order as:

- 701-03 Heavy Vehicle Lighting Circuits Trainer

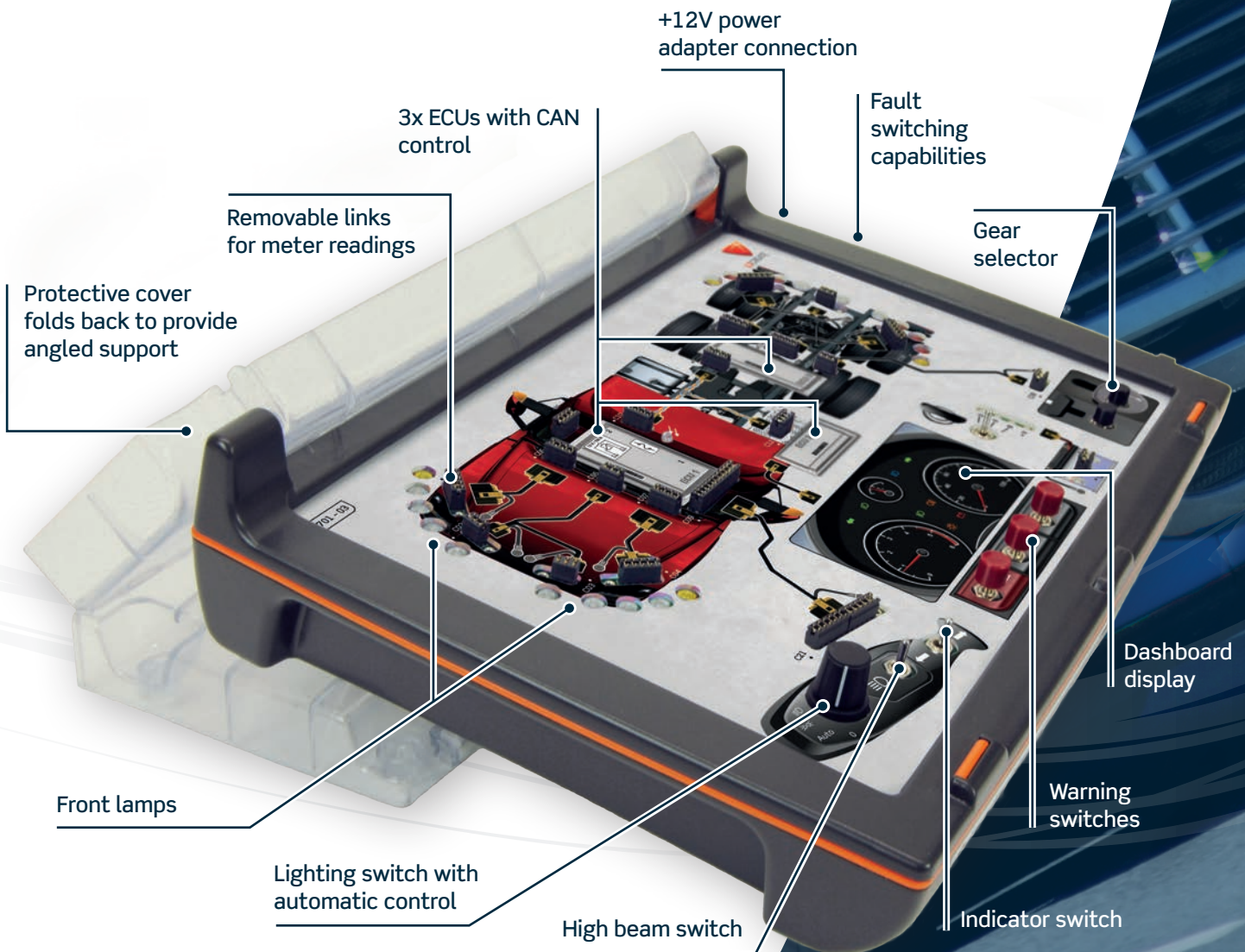

Light Vehicle Repair Trainers

Examples from our range

Our light vehicle repair trainers have been designed to provide comprehensive hands-on troubleshooting practice, helping your students gain the real-world skills they need for a successful career in the automotive industry.

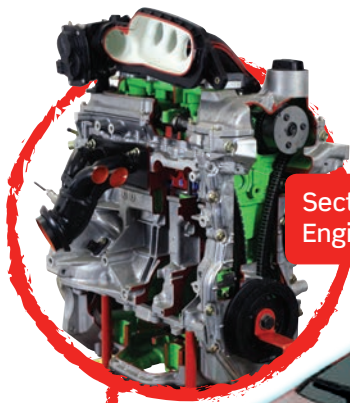

Sectioned Gasoline Engine Trainer

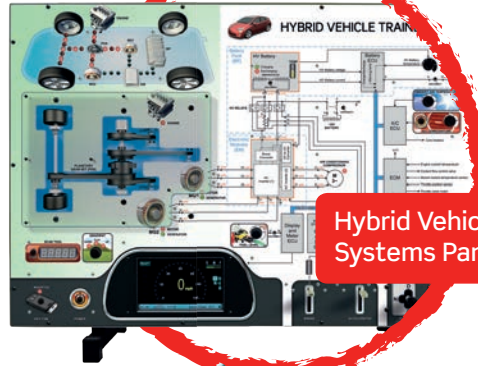

Hybrid Vehicle Systems Panel Trainer

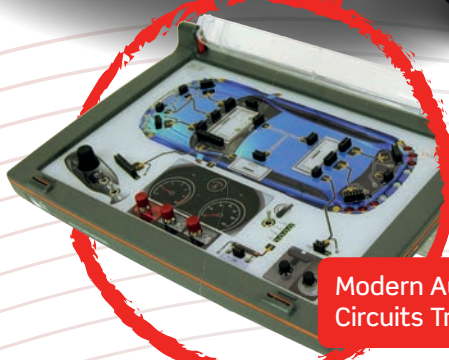
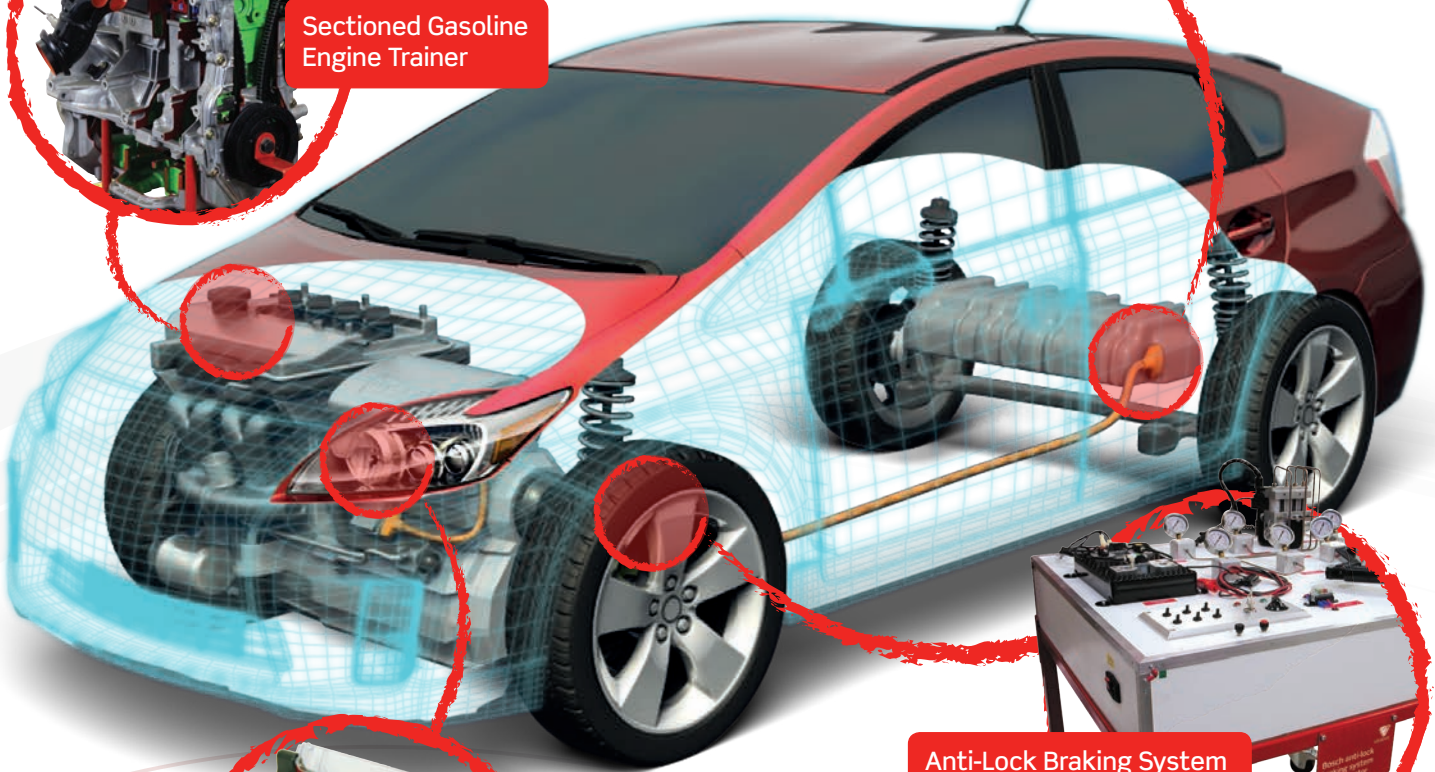

Modern Auto Lighting Circuits Trainer



Anti-Lock Braking System (Bosch) Trainer

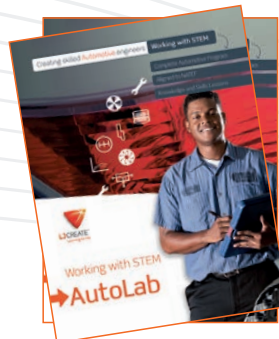

Our complete AutoLab brochure features our full range of light and heavy vehicle resources - contact us to receive your copy!

Create your own AutoLab

AutoLab is uniquely flexible

We can create an AutoLab for you and your school or college that responds to your space, course, and budget requirements. Take a look at the diagram below for just one example of an AutoLab configuration.

Knowledge Lessons Zone

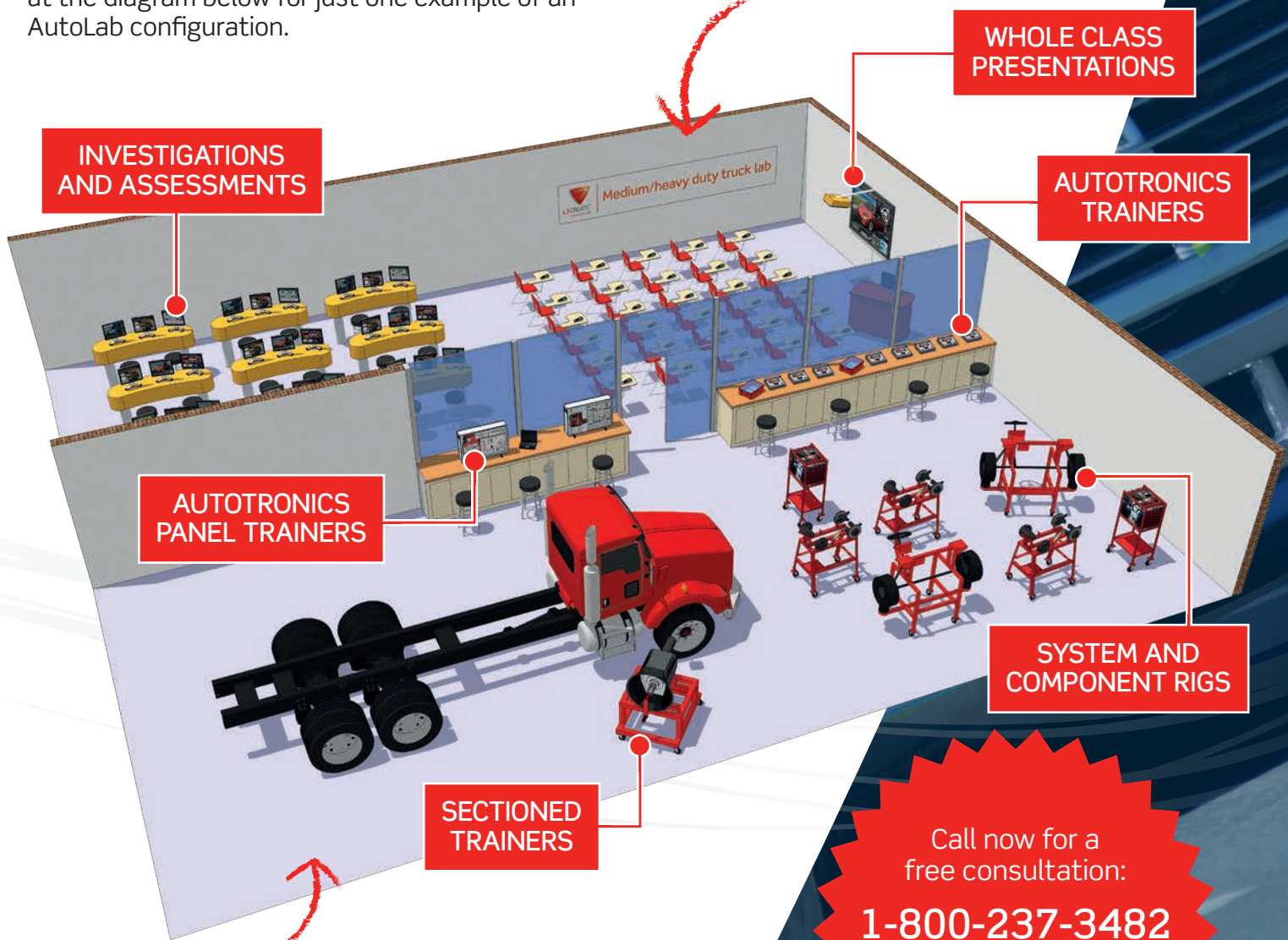

Skills Lessons Zone

Call now for a free consultation:

1-800-237-3482

or visit our website:

ljcreate.com

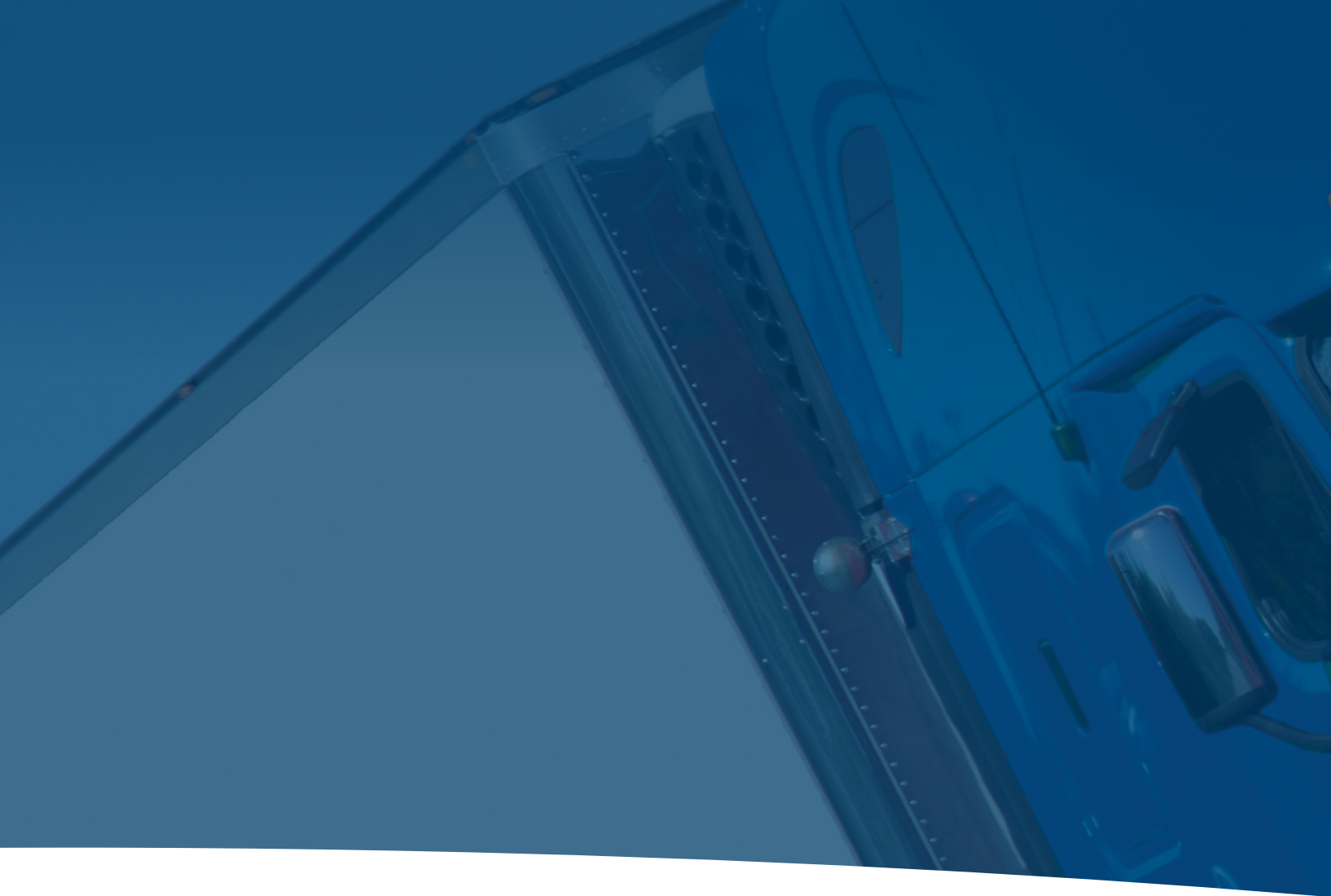

For more information on our range of learning resources, please contact:

LJ Create

2400 Lake Orange Drive,
Suite 105
Orlando, FL 32837

T: 1-800-237-3482
E: info@ljcreate.com

ljcreate.com

LJ Create recognizes all product names used in this document as trademarks or registered trademarks of their respective holders. We reserve the right to change the contents of any module or program. Images are for illustrative purposes only, actual product may vary. For the latest information on any of our products, please visit our website.